

### 75Ω BNC Crimp Plugs

Canare added the new BCP-D series for 12G-SDI. SMPTE ST 2082-1 fully compliant connector makes UHD solutions as simple as existing SDI systems. The world's highest quality BNC includes BCP-B for 3G-SDI, BCP-A/C for up to HD.

#### ■ BCP-D Series 12G-SDI

Return Loss: 20 dB @ 6 GHz, 15 dB @ 12 GHz

Model	Suitable Cable		Center Pin	Sleeve	Boot	Die Set
	Canare	Others				
<b>NEW</b> BCP-D33UHD	L-3.3CUHD	—	BN1181	BN7003A	CB03	TCD-35CA
<b>NEW</b> BCP-D55UHD	L-5.5CUHD	—	BN1175	B75004A	—	TCD-55UHD
<b>NEW</b> BCP-D57	—	4794R	BN1192	BN7002	—	TCD-57C

• Standard package (20pcs/100pcs)

#### ■ BCP-B Series

Return Loss: 26.4 dB @ 3 GHz

Model	Suitable Cable		Center Pin	Sleeve	Boot	Die Set
	Canare	Others				
<b>NEW</b> BCP-B25HD	L-2.5CHD, L-2.5CHLT	VDM230	B11015E	BN7129	CB02	TCD-35CA
<b>NEW</b> BCP-B25HW	L-2.5CHWS, V4-2.5CHW	—	B11015E	BN7143	CB02	TCD-35CA
<b>NEW</b> BCP-B26	—	1855A, 1855P	B11014E	BN7029C	CB02	TCD-35CA
<b>NEW</b> BCP-B28	—	1855ENH, HD PRO 0.6/2.8 AF	B11015E	BN7052A	CB02	TCD-35CA
<b>NEW</b> BCP-B3F	L-3CFB, V*-3CFB	—	B11015E	BN7003A	CB03	TCD-35CA
<b>NEW</b> BCP-B31F	L-3CFW, V*-3CFW	—	B11015E	BN7015A	CB04	TCD-4CA, TCD-451CA
<b>NEW</b> BCP-B4F	L-4CHD, L-4CFB, V*-4CFB	1505A, 1505ANH, VPM2000, HD PRO 0.8/3.7 AF	B11016E	BN7015A	CB04	TCD-4CA, TCD-451CA
<b>NEW</b> BCP-B45HW	L-4.5CHWS	1694F	B11020D	BN7016	CB05A	TCD-35CA
<b>NEW</b> BCP-B53	L-4.5CHD	1694A	B11020D	BN7046	CB05A	TCD-35CA
<b>NEW</b> BCP-B56	—	HD PRO 1.0/4.8 AF	B11020D	BN7046	CB05A	TCD-35CA
<b>NEW</b> BCP-B5F	L-5CFB, V*-5CFB	—	B11020D	B75004A	CB05A	TCD-5CF, TCD-55FA
<b>NEW</b> BCP-B51F	L-5CFW, V*-5CFW	—	B11020D	B75004A	CB05A	TCD-5CF, TCD-55FA

• Standard package (20pcs/100pcs)

#### ■ BCP-A Series

Return Loss: 26.4 dB @ 2 GHz, 20.8 dB @ 3 GHz (\*1)

Model	Suitable Cable		Center Pin	Sleeve	Boot	Die Set
	Canare	Others				
<b>NEW</b> BCP-A25	L-2.5C2V	—	BN1018A	BN7029C	CB02	TCD-35CA
<b>NEW</b> BCP-A25F	L-2.5CFB	1855A, 8218, 1417B, 1418B	B11014E	BN7029C	CB02	TCD-35CA
<b>NEW</b> BCP-A3	L-3C2VS, L-3C2V, V*-3C	—	B11014E	BN7003A	CB03	TCD-35CA
<b>NEW</b> BCP-A31	L-3C2W	—	B11014E	BN7011	CB04	TCD-31C
<b>NEW</b> BCP-A32	—	1506A, 1824A, 1825A, 1826A, 643948	B11016E	BN7026A	CB03	TCD-35CA
<b>NEW</b> BCP-A3F	L-3CFB, V*-3CFB	—	B11015E	BN7003A	CB03	TCD-35CA
<b>NEW</b> BCP-A4	LV-61S	8241, 8279, RG-59B/U	B11015E	BN7015A	CB04	TCD-4CA, TCD-451CA
<b>NEW</b> BCP-A42	—	1505F	B11016E	BN7011	CB04	TCD-31C
<b>NEW</b> BCP-A4F	L-4CHD, L-4CFB, V*-4CFB	1505A, 1505ANH, 8212, 8241F, 9167, 9259, 9659, VPM2000, HD PRO 0.8/3.7 AF	B11016E	BN7015A	CB04	TCD-4CA, TCD-451CA
<b>NEW</b> BCP-A5	L-5C2VS, L-5C2V, V*-5C	—	B11016E	BN7016	CB05A	TCD-35CA
<b>NEW</b> BCP-A52	L-5C2W	—	B11016E	BN7014	—	TCD-451CA
<b>NEW</b> BCP-A55	—	1695A, VSD2001TS	B11020D	BN7045A	CB04	TCD-35CA
<b>NEW</b> BCP-A5F	L-5CFB, V*-5CFB	—	B11020D	B75004A	CB05A	TCD-35CA
<b>NEW</b> BCP-A77	LV-77S	8281F	B11016E	B75004A	CB05A	TCD-5CF, TCD-55FA
<b>NEW</b> BCP-VA3	V*-3C	—	B11014E	BN7052A	CB03	TCD-35CA
<b>NEW</b> BCP-VA5	V*-5C	—	B11016E	BN7045A	CB05A	TCD-35CA

• Standard package (20pcs/100pcs).

Note: Suitable die set for BCP-A5F is TCD-35CA; do not use TCD-5CF/TCD-55FA for BCP-A5F.

\*1 Excluding BCP-A25, BCP-A25F and BCP-A4

- Canare crimp design ensures quick and reliable installation.
- Gold plated "snap locks" center pin and beryllium copper outer contact.
- Elongated body design for stable finger grip.
- Position mark on the body makes it easier to check if the connector is locked.

Be sure to use Canare Crimp Tool.



BCP-D55UHD

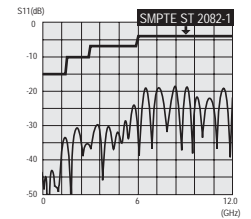

Return loss for BCP-D55UHD



BCP-B5F

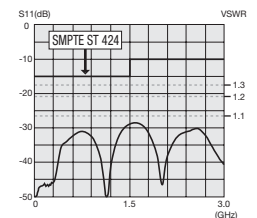

Return loss for BCP-B5F



BCP-A3

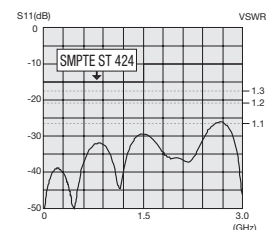

Return loss for BCP-A3

## ■ BCP-C Series

Return Loss: 26.4 dB @ 2 GHz (\*2)

Model	Suitable Cable		Center Pin	Sleeve	Boot	Die Set
	Canare	Others				
BCP-C1	L-1.5C2VS, V*-1.5C	83264, 83267	Solder	BN7022	CB01	TCD-1DB
BCP-C5HD	L-5CHD	—	BN1139	B75004A	CB05A	TCD-5HD
BCP-C6HD	L-6CHD	—	BN1083A	BN7074A	—	TCD-67HD
BCP-C71A	—	7731A, 9064, 9292, 1617A, 9011	BN1043A	BN7021A	—	TCD-7CA
BCP-C7FA	L-7CFB	—	BN1012B	BN7021A	—	TCD-7CA
BCP-C7HD	L-7CHD	—	BN1082A	BN7021A	—	TCD-67HD
BCP-C8HD	L-8CHD	—	BN1174	BN7147	—	TCD-8HD

• Standard package (20pcs/100pcs).

\*2: Excluding BCP-C1 and BCP-C8HD

Note: Crimp tool for TCD-8HD is TC-2.



BCP-C6HD

## ■ BCP-LC Series (Right Angle)

Return Loss: 26.4 dB @ 2 GHz

Model	Suitable Cable		Center Pin	Sleeve	Boot	Die Set
	Canare	Others				
BCP-LC3	L-3C2VS, L-3C2V, V*-3C	—	B11014E	BN7003A	—	TCD-35CA
BCP-LC3F	L-3CFB, V*-3CFB	—	B11015E	BN7003A	—	TCD-35CA
BCP-LC5	L-5C2VS, L-5C2V, V*-5C	—	B11016E	BN7016	—	TCD-35CA
BCP-LC5F	L-5CFB, V*-5CFB	—	B11020D	B75004A	—	TCD-5CF, TCD-55FA

• Standard package (20pcs)

- Canare crimp design ensures quick and reliable installation.
- Gold plated “snap locks” center pin and beryllium copper outer contact.
- Return loss for BCP-C8HD: 26.4 dB @ 3 GHz

Be sure to use Canare Crimp Tool.



BCP-LC3

## 75 Ω Slim BNC Crimp Plugs

### ■ MBCP-C Series

Return Loss: 26.4 dB @ 1.5 GHz (\*3)

Model	Suitable Cable		Center Pin	Sleeve	Boot	Die Set
	Canare	Others				
MBCP-C25F	L-2.5CFB	1855A, 8218, 1417B, 1418B	B11014E	BN7029C	—	TCD-35CA
MBCP-C3F	L-3CFB, V*-3CFB	—	B11015E	BN7003A	CB24	TCD-35CA
MBCP-C4	LV-61S	8241, 8279, RG-59B/U	B11015E	BN7015A	CB25	TCD-4CA, TCD-451CA
MBCP-C4F	L-4CFB, V*-4CFB	1505A, 1505ANH, 8212, 8241F, 9167, 9259	B11016E	BN7015A	CB25	TCD-4CA, TCD-451CA
MBCP-C53	L-4.5CHD	1694A, 9066, 9116, 9118, 9248	B11020D	BN7046	CB26	TCD-35CA
MBCP-C5F	L-5CFB, V*-5CFB	—	B11020D	B75004A	CB26	TCD-5CF, TCD-55FA

• Standard package (20pcs/100pcs)

\*3: Excluding MBCP-C25F

- Slim design: OD 12 mm
- Compatible with 75 Ω BNC receptacles.
- Canare crimp design ensures quick and reliable installation.
- Gold plated “snap locks” center pin and beryllium copper outer contact.

Be sure to use Canare Crimp Tool.



Standard BNC Plug

Slim BNC Plug

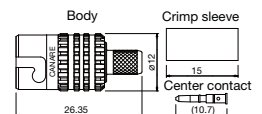

MBCP-C3F

## Technical Note

### Voltage Standing-wave Ratio (VSWR) and Return Loss

Terminating the receiving end of a limited length coaxial cable using a resistance value not equal to its characteristic impedance creates a reflected wave that returns back down the cable to the sending end. The result is interference developing between the travelling wave and the return wave which results in a standing wave that causes voltage levels to fluctuate. The degree to which terminating resistance matches the characteristic impedance is indicated using the VSWR or voltage standing-wave ratio standard shown in Fig. 1. Going hand in hand with the VSWR ratio is the return loss factor which measures the size of the reflected wave current in relation to the travelling wave current. (See Fig. 2)

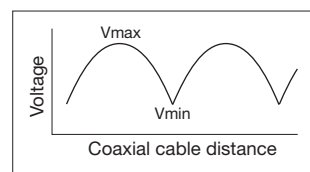

Fig. 1 Voltage Distribution Over Coaxial Cable

VSWR	Return Loss (dB)
2	9.54
1.5	13.98
1.2	20.83
1.1	26.44
1.05	32.26
1.02	40.09
1.01	46.06

Fig. 2 VSWR to Return Loss Conversion Table

### 75Ω BNC Solder Plugs

#### ■ BCP-H Series

Return Loss: 26.4 dB @ 1 GHz

Model	Suitable Cable	
	Canare	Others
BCP-H3B	L-3C2VS, L-3C2V, L-3CFB	—
BCP-H31F	L-3CFW	—
BCP-H45HW	L-4.5CHWS	1694F
BCP-H5B	L-5C2VS, L-5C2V, L-5CFB	—
BCP-H51F	L-5CFW, L-5CFB	—
BCP-H5/1	L-3C2VS, L-3C2V, L-3CFB	—
	L-5C2VS, L-5C2V, L-5CFB	

• Standard package (20pcs)

- The tubular (ferrule) section is silver plated to make soldering easier.
- Cable stripper TS100E can be used. (Excluding BCP-H31F, BCP-H51F)



BCP-H3B

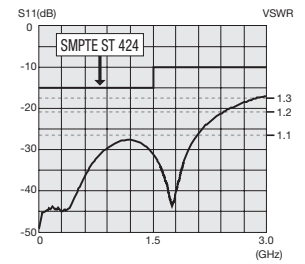

Return loss for BCP-H3B

### 75Ω BNC Jack Plug

Model	Suitable Cable	Boot	Die Set
BCJ-C4	RG-59 B/U, LV-61S, Belden 8241, 8279, 88241	CB25	TCD-4CA TCD-451CA

• Standard package (20pcs)

- Return loss: 26.4 dB @ 1.5 GHz, 20.8 dB @ 2.4 GHz
- Beryllium copper (gold plated) is used on the center contact for its superior spring characteristics. (Center contact: solder)

Be sure to use Canare Crimp Tool.



BCJ-C4

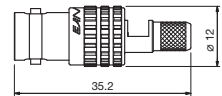

BCJ-C4

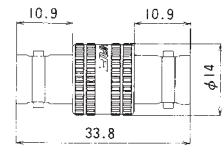

BCJ-J

### 75Ω BNC Extension Adapter

Model	Description
BCJ-JK	Jack to Jack, for 12G-SDI

• Standard package (20pcs/100pcs)

- Return loss for BCJ-JK: 15 dB @ 12 GHz



BCJ-JK

12G-SDI

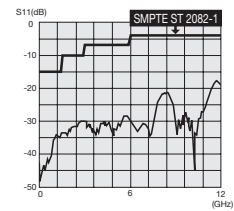

Return loss for BCJ-JK

### 75Ω BNC Termination Plugs

Model	Description
BCP-TK	True 75Ω Termination, for 12G-SDI
BCP-TB	True 75Ω Termination
BCP-TK-CH	BCP-TK with String
BCP-TB-CH	BCP-TB with String

• Standard package (20pcs/100pcs)

- Includes 1/4 watt resistance.
- Return loss for BCP-TK: 26.4 dB @ 3 GHz, 15 dB @ 12 GHz
- Return loss for BCP-TB: 26.4 dB @ 3 GHz



BCP-TK

12G-SDI

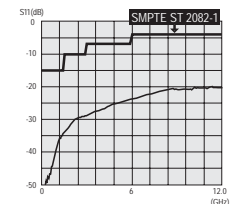

Return loss for BCP-TK

### Connector Boots

#### ■ CB0x Series

Our best selling connector boots for Canare BNC, TNC crimp plugs.

Model	Colors Available	BCP-xx	BP-xx	TNP-xx
CB01	BLK, BLU, GRN, RED, YEL, WHT	C1		
CB02		B25HD, B25HW, B26, B28, A25, A25F		
CB03	BLK, BLU, BRN, GRN, GRY,	D33UHD, B3F, B31F, A3, A32, A3F, VA3	C3, C4	C3, C4
CB04	ORN, PPL, RED, YEL, WHT	B4F, A31, A4, A42, A4F, A55	C31	C31
CB05A		B53, B56, B5F, B51F, A5, A5F, A77, VA5, C5HD	C5, C5FA	C5

#### ■ CB2x Series

Thinner type of CB0x series. Best fit for Canare Slim BNC, RCA, and F crimp plugs.

Model	Colors Available	Typical Connectors		
		MBCP-xx	RCAP-xx	FP-xx
CB24		C3F	C3A, C3F	C3, C3F
CB25	BLK, BLU, GRN, RED, YEL, WHT	C4, C4F	C3GS, C4A, C4F	C31, C4, C4F
CB26		C5F	C53, C5A, C5F	C5, C53A, C5F

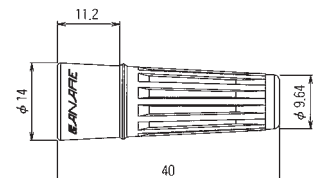

CB03, CB04, CB05A

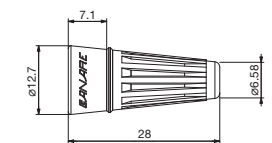

CB01, CB02



CB24, CB25, CB26

## 75Ω BNC Receptacles

### Jack to Jack 12G-SDI Return Loss: 15 dB @ 12 GHz

Model	Description	Flange
BCJ-JRK	Standoff	—
BCJ-JRUK	Flush-mount	ITT XLR-F77
BCJ-JRUDK		Neutrik D
BCJ-JRUBK		Neutrik D (Black)

- Standard package (20 pcs)
- Redesigned for 12G-SDI to minimize return loss.

### Jack to Jack Return Loss: 26.4 dB @ 2 GHz

Model	Description	Flange
BCJ-JR	Standoff	—
BCJ-JRU	Flush-mount	ITT XLR-F77
BCJ-JRUD		Neutrik D
BCJ-JRUBD		Neutrik D (Black)

- Standard package (20 pcs)

### Jack to Solder Return Loss: 26.4 dB @ 2 GHz

Model	Description	Flange
BCJ-R	Rear-mount	—
BCJ-R/1	Rear-mount, w/Ground Lug	—
BCJ-RU	Flush-mount	ITT XLR-F77
BCJ-RUD		Neutrik D
BCJ-RUBD		Neutrik D (Black)

- Standard package (20 pcs)

### Panel Jack (Jack to Solder and Crimp) Return Loss: 26.4 dB @ 1 GHz

Model	Description	Flange	Suitable Cable	Die Set
BCJ-FC1	Front-mount, 1/2"	—	1.5C-2V	TCD-1DB
BCJ-FC1-7/16	Front-mount, 7/16"	—		
BCJ-RUC1	Flush-mount	ITT XLR-F77		

- Standard package (20 pcs)
- Panel Jack covers the rear wiring part with metal crimp sleeve.
- Flush-mount receptacle prevents damage on the jack.

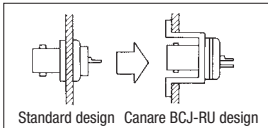

### Panel Hole Dimensions

BCJ-R	★BCJ-R/1 ★BCJ-JR(K)	BCJ-FC1	★BCJ-FC1-7/16	BCJ-RUC1 BCJ-RU BCJ-JRU(K)	BCJ-RUD BCJ-RUBD BCJ-JRUD(K) BCJ-JRUBD(K)

★ marked models accept insulation bushing IU-7/16, and the panel hole for IU-7/16 should be adopted in this case. (see below)

### Insulation Bushing

Model	Description
IU-7/16	ABS plastic

- Standard package: 20pcs
  - Insulate a connector from a panel.
  - 5 colors available (white, black, blue, green, red, or yellow)
- Note:** Please remove washers from a connector before using IU-7/16.

Panel Thickness:

1.2 to 1.5 mm: BCJ-DCJ, BCJ-FPLHA, BCJ-FPLV-12G, BCJ-FPLV-L, BCJ-FPLVA, BCJ-R/1

1.2 to 3.0 mm: BCJ-FC1-7/16, BCJ-FPC, BCJ-FPC02, BCJ-FPLV01, BCJ-JR(K), BJ-JR, FJ-JR, FJ-FPC, NCJ-BCJR, RJ-JR



BCJ-JRK

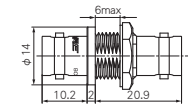

BCJ-JRK



BCJ-JRUK

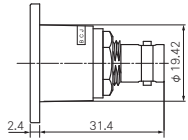

BCJ-JRUK



BCJ-R/1

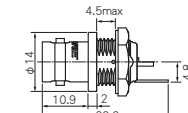

BCJ-R/1

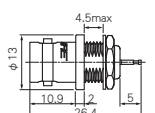

BCJ-R



BCJ-RU

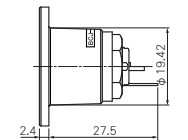

BCJ-RU



BCJ-RUD

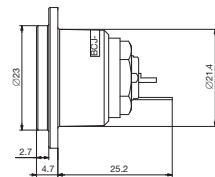

BCJ-RUD



BCJ-FC1-7/16

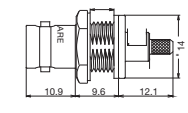

BCJ-FC1-7/16

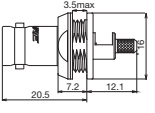

BCJ-FC1



BCJ-RUC1

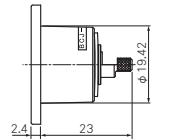

BCJ-RUC1

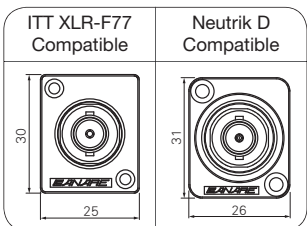

ITT XLR-F77 Compatible

Neutrik D Compatible



IU-7/16

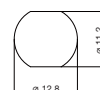

Panel Hole Dimensions

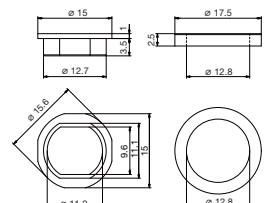



### 75Ω BNC PCB Mount Receptacles (Screw Type)

#### BCJ-BP Series

Model	Description	Stud Position	Panel Mount	Standard Package
<b>BCJ-BPLHK</b>	Right Angle, for 12G-SDI	Horizontal	Front: M2.6 screw	20 pcs/100 pcs
<b>BCJ-BPLHA</b>	Right Angle			20 pcs/100 pcs
<b>BCJ-BPLH2PA</b>	Right Angle, Dual Jack	—	—	10 pcs
<b>BCJ-BPLH3PA</b>	Right Angle, Triple Jack			10 pcs
<b>BCJ-BPC2P</b>	Straight, Dual Jack	—	—	10 pcs/100 pcs

Screws not included

#### Key Features and Benefits

- True 75Ω PC board mount receptacle.
- Return loss:
  - BCJ-BPLHK: 26 dB @ 1.5 GHz, 20 dB @ 3 GHz, 15 dB @ 6 GHz, 10 dB @ 12 GHz
  - BCJ-BPLHA: 26 dB @ 1.5 GHz, 20 dB @ 3 GHz
  - BCJ-BPC2P: 26 dB @ 1 GHz, 20 dB @ 2.5 GHz
- Gold plated beryllium copper center contact.
- Can be fixed on the PC board with M2.6 screw for efficient soldering. (excluding BCJ-BPC2P)
- Space-saving design allows high-density mounting.
- Eliminates wiring material and cost.

Note: Any cleaning solvents cannot be used. This leads to insulation problems.  
Insulation material: m-PPO (m-PPE)

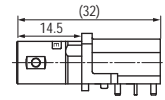

**BCJ-BPLHK**  
**12G-SDI**

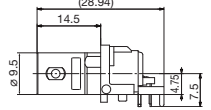

**BCJ-BPLHA**

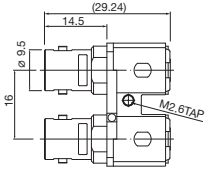

**BCJ-BPLH2PA**

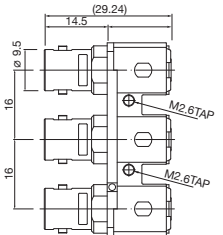

**BCJ-BPLH3PA**

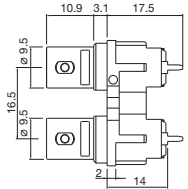

**BCJ-BPC2P**

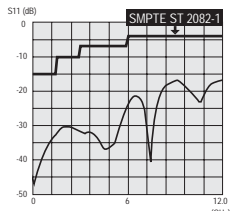

Return loss for BCJ-BPLHK

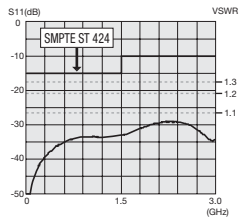
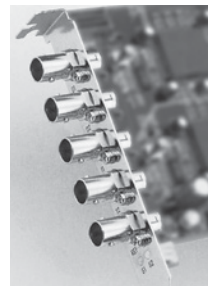

Return loss for BCJ-BPLHA

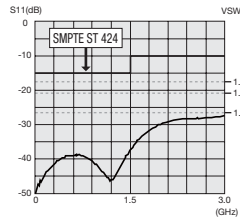

Return loss for BCJ-BPLH2PA

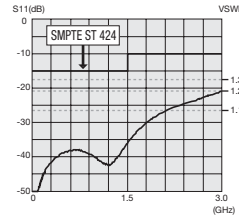

Return loss for BCJ-BPC2P

	BCJ-BPLHK	BCJ-BPLHA	BCJ-BPLH2PA	BCJ-BPLH3PA	BCJ-BPC2P
<b>Panel Hole Dim.</b>	<p>Screw: M2.6 t1.6</p>	<p>Screw: M2.6 t1.6</p>	<p>Screw: M2.6 t1.6</p>	<p>Screw: M2.6 t1.6</p>	<p>Screw: M2.6 t1.2</p>
<b>PCB Hole Dim.</b>	<p>t2.0 (BOTTOM VIEW)</p>	<p>t2.0 (BOTTOM VIEW)</p>	<p>t1.6 (BOTTOM VIEW)</p>	<p>t1.6 (BOTTOM VIEW)</p>	<p>t1.6 (BOTTOM VIEW)</p>

## 75Ω BNC PCB Mount Receptacles (Hex Nut Type)

### BCJ-FP Series

Model	Description	Stud Position	Panel Mount
BCJ-FPLV-12G	Right Angle, for 12G-SDI	Vertical	Front: Hex nut and lock washer
BCJ-FPLVA	Right Angle		
BCJ-FPLV01	Right Angle, Low Cost		
BCJ-FPLV-L	Right Angle, Long Neck		
BCJ-FPLHA	Right Angle	Horizontal	
BCJ-FPC	Straight	—	
BCJ-FPC02	Straight, Low Cost	—	

•Standard package: 20pcs/100pcs, except for BCJ-FPLV-L (10pcs).

### BCJ-RP Series

Model	Description	Stud Position	Panel Mount
BCJ-RPLV	Right Angle	Vertical	Rear: Hex nut and lock washer
BCJ-RPLH	Right Angle	Horizontal	
BCJ-RPC	Straight, Through Hole Mount	—	
BCJ-RPC/1	Straight, Surface Mount	—	

•Standard package: 20pcs/100pcs.

- BCJ-FPLV-12G is specially designed to minimize the return loss for 12G-SDI.
- Return loss: BCJ-FPLV-12G: 15 dB @ 6 GHz, 10 dB @ 12 GHz,  
BCJ-FPLV-L: 26.4 dB @ 3 GHz, Others: 26.4 dB @ 1 GHz.

Note: Any cleaning solvents cannot be used. This leads to insulation problems.  
Insulation material: m-PPO (m-PPE)



**BCJ-FPLV-12G**  
**12G-SDI**

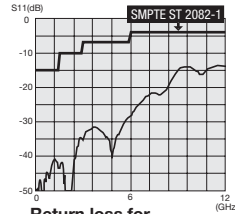

Return loss for  
BCJ-FPLV-12G

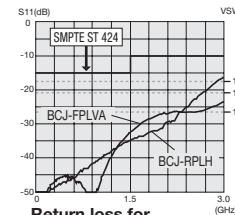

Return loss for  
BCJ-FPLVA, BCJ-RPLH

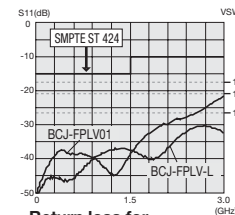

Return loss for  
BCJ-FPLV01, BCJ-FPLV-L

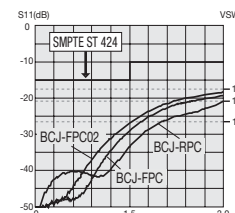

Return loss for  
BCJ-FPC, BCJ-FPC02,  
BCJ-RPC

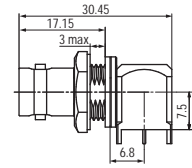

**BCJ-FPLV-12G**

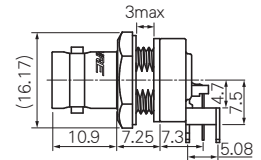

**BCJ-FPLVA**

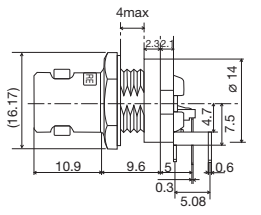

**BCJ-FPLV01**

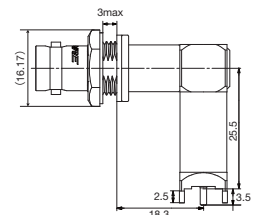

**BCJ-FPLV-L**

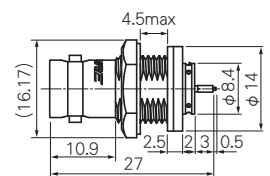

**BCJ-FPC**

### <Panel Hole Dimensions>

BCJ-FPLV-12G* BCJ-FPLVA* BCJ-FPLV01* BCJ-FPLV-L*	BCJ-FPLHA*	BCJ-FPC* BCJ-FPC02*	BCJ-RPC/1 BCJ-RPC BCJ-RPLV BCJ-RPLH

\* BCP-FP series accept insulation bushing IU-7/16, and the panel hole for IU-7/16 should be adopted in this case. (see page 33)

### <PC Board Hole Dimensions>

BCJ-FPLV-12G	BCJ-FPLVA BCJ-FPLV01 BCJ-FPLHA	BCJ-FPLV-L	BCJ-FPC BCJ-FPC02	BCJ-RPLV BCJ-RPLH	BCJ-RPC
t 2.0	t 2.0	t 2.0	t 2.0	t 3.0	t 1.6

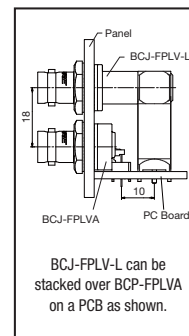

BCJ-FPLV-L can be stacked over BCP-FPLVA on a PCB as shown.

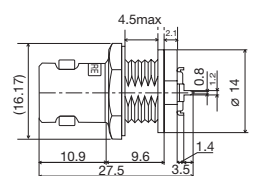

**BCJ-FPC02**

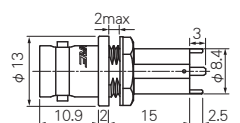

**BCJ-RPC**

### 75Ω Active BNC Receptacles

Small BNC connector incorporates either a cable equalizer or a cable driver. Active BNC makes innovation in your 3G-SDI PC board layout.

Model	Description	Built-in IC
BCA-TL	TX, Right Angle	Cable Driver
BCA-RL	RX, Right Angle	Cable Equalizer
BCA-TS	TX, Straight	Cable Driver
BCA-RS	RX, Straight	Cable Equalizer

• Standard package (5pcs)

- BNC connector integrated with a cable equalizer or a cable driver, and yet keep the connector size to a minimum.
- Supports 3G-SDI, HD-SDI, SD-SDI and DVB-ASI
- Offers an excellent return loss performance without designing 75 ohm I/O block
- Simplifies PCB design process dramatically and will reduce entire development cost
- PCB space saving and help to downsize devices
- Easy to distinguish TX from RX by color-coded insulation

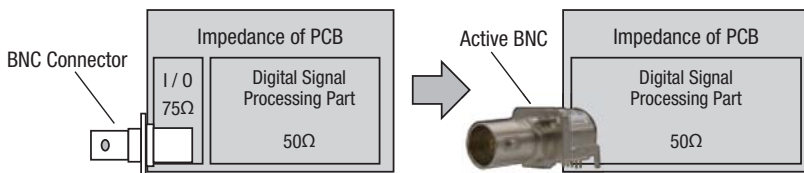

Simplify Your Circuit Design

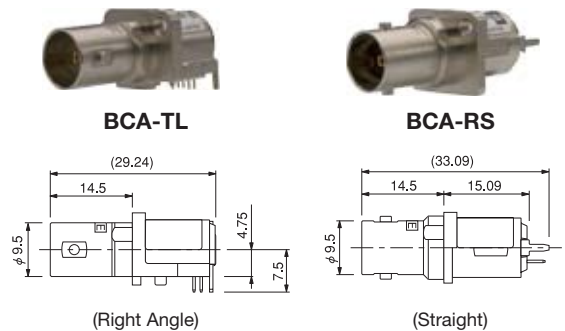

(Right Angle)

(Straight)

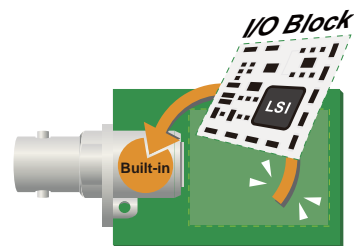

Space-saving

### Specifications

Model	TX BCA-TL, BCA-TS	RX BCA-RL, BCA-RS
Supply Voltage	DC 3.3V	
Current Consumption	50mA	70mA
Operating Temperature	-25°C to +85°C	
Output Signal Amplitude	800mVpp	—
Equalizing Cable Length	—	3G-SDI 120m w/L-5CFB
Compliant	SMPTE 424M, 292M, 259M, BTA S-004C, EN50083-9	
Weight	Approx. 9.0g	

US Patent No.: 8251721 B2  
JP Patent No.: 4837715

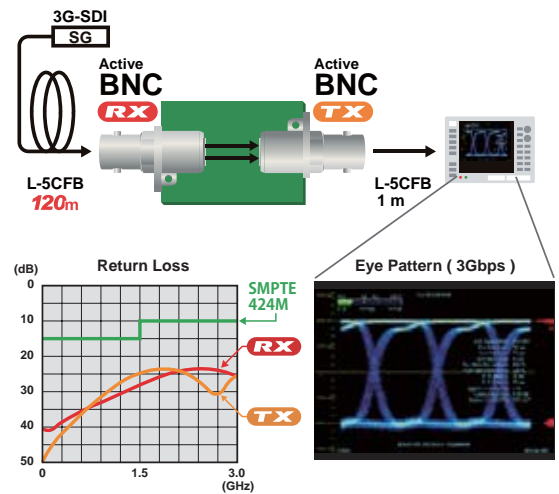

	BCA-TL	BCA-RL	BCA-TS	BCA-RS
Panel Hole Dim.	<p>t1.6 Screw: M2.6</p>		<p>t1.6 Screw: M2.6</p>	
PCB Hole Dim.	<p>t2.0 (TOP VIEW)</p> <p>Pin 8 5 0 0 0 0 1234 1 : GND 2 : SDI+ 3 : SDI- 4 : Vcc 5 : SD/HD 7 : - 8 : ENABLE</p>	<p>t2.0 (TOP VIEW)</p> <p>Pin 1234 0 0 0 0 1 : GND 2 : SDO+ 3 : SDO- 4 : Vcc</p>	<p>t2.0 (TOP VIEW)</p> <p>Pin 4321 0 0 0 0 5 8 1 : GND 2 : SDI+ 3 : SDI- 4 : Vcc 5 : SD/HD 6 : - 7 : - 8 : ENABLE</p>	<p>t2.0 (TOP VIEW)</p> <p>Pin 4321 0 0 0 0 1 : GND 2 : SDO+ 3 : SDO- 4 : Vcc</p>

Note: The darker shaded area will come into contact with the connector body.

## BNC Dust Caps

Model	Description
BCJ-DC	Polyethylene (Black)
BCJ-DC-CH	Polyethylene (Black) with string

•Standard package (20pcs/100pcs)

- Protects unused BNC receptacles from dirt and dust.

## BNC - RCA Adapter

Model	Description
BCP-RCAJ	RCA Jack (F) to BNC Plug (M)
BCJ-RCAP	BNC Jack (F) to RCA Plug (M)

•Standard package (1pc)

- Gold plated center contact
- Secure finger grip and reliable mating

## 75Ω N Solder Plug

Return Loss: 26.4 dB @ 2 GHz

Model	Suitable Cable
NCP-H8HD	L-8CHD

•Standard package (1pc)

- Gold plating on the contact pin prevents deterioration, even after years of use.
- Return loss: 26.4 dB @ 2 GHz
- Solder type

Tools required: 17 mm and 21 mm wrenches

Caution: The connecting section of the N connector uses a shape that conforms to the IEC169-16's 75Ω impedance standard. Note that the 50Ω N and other connectors that do not conform to this specification cannot be connected.

## 75Ω N to BNC Adapter

Return Loss: 26.4 dB @ 2 GHz

Model	Description
NCJ-BCJR	N (F) - BNC (F)

•Standard package (1pc)

- Beryllium copper (gold plated) is used on the center contact for its superior spring characteristics.
- Return loss: 26.4 dB @ 2 GHz
- Panel mountable as well. For isolation from the panel, use Canare isolation bushing IU-7/16.(see page 33)



BCJ-DC



BCP-RCAJ



BCJ-RCAP

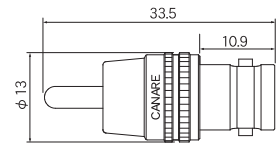
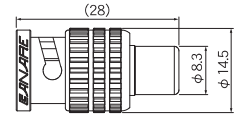

NCP-H8HD

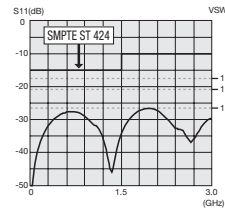
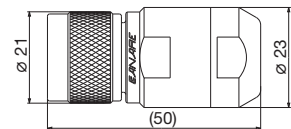

Return loss for NCP-H8HD



NCJ-BCJR

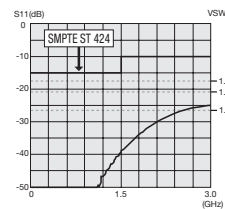
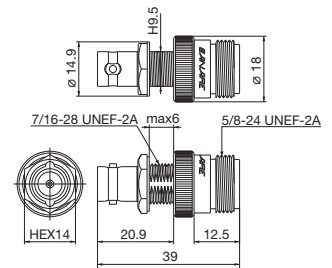

Return loss for NCJ-BCJR

Panel Hole Dimensions



### 75Ω DIN 1.0/2.3 Connectors

Mini coax connectors IEC61169-29 and DIN 47 297 compatible.

#### DCP-C Series (Crimp Plugs)

Return Loss: 20.8 dB @ 3 GHz

Model	Suitable Cable		Center Pin	Sleeve	Boot	Die Set
	Canare	Others				
DCP-C25HD	L-2.5CHD, L-2.5CHLT	1855A, VDM230	BN1148	BN7136	—	TCD-D253F
DCP-C25HW	L-2.5CHWS, V4-2.5CHW	—	BN1148	BN7141	—	TCD-D253F
DCP-C3F	L-3CFB	—	BN1148	BN7003A	—	TCD-D253F
DCP-C4F	L-4CHD, L-4CFB	1505A, VPM2000	BN1158	BN7015A	—	TCD-D534F
DCP-C53	L-4.5CHD	1694A, VSD2001	BN1157	BN7138	—	TCD-D534F

•Standard package (20pcs/100pcs)

- Our unique ball-locking mechanism offers smooth and reliable mating.
- Canare crimp design ensures quick and reliable installation.
- Elongated body design enables stable finger grip.
- Return loss: 20.8 dB or greater up to 3 GHz
- Extraction tool : BET-DIN (see page 46)

US Patent No.: 8764473 B2

Be sure to use Canare Crimp Tool

#### PCB Mount Receptacles

Return Loss: 20.8 dB @ 3 GHz

Model	Description	Nut Driver Bit
DCJ-LR	Right Angle	NDT-DIN
DCJ-LR/1	Right Angle, Long type	
DCJ-FEM	Edge Mount	

•Standard package (20 pcs)

- Compact design ideal for high density mounting and downsizing devices.
- Combination of DCJ-LR/1 and DCJ-FEM will be effective for staggered arrangement.
- Return loss: 20.8 dB or greater up to 3 GHz.

Note: Nut driver bit NDT-DIN is required.

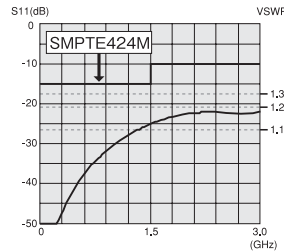

Return Loss for DCJ-LR

#### Adapters

Return Loss: 26.4 dB @ 3 GHz

Model	Description	Panel Mount	Nut Driver Bit
DCJ-JR	Jack to Jack	Yes	NDT-DIN
BCJ-DCJ	BNC Jack to DIN1.0/2.3 Jack	Yes	N/A
BCP-DCJ	BNC Plug to DIN Jack	No	N/A

•Standard package (20 pcs)

- Return loss: 26.4 dB or greater up to 3 GHz.

Note: Nut driver bit NDT-DIN is required for DCJ-JR

#### <Panel Hole Dim.>

DCJ-LR DCJ-LR/1 DCJ-FEM DCJ-JR	BCJ-DCJ*

#### <PCB Hole Dim.>

DCJ-LR DCJ-LR/1	DCJ-FEM

\*BCJ-DCJ accepts insulation bushing IU-7/16, and the panel hole for IU-7/16 should be adopted in this case. (see page 33)

#### Nut Driver Bit

Model	Description
NDT-DIN	6.35mm (1/4") hex shank



DCP-C25HD

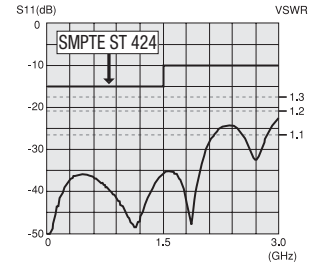

Return Loss for DCP-C25HD

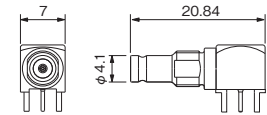

DCJ-LR

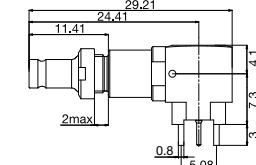

DCJ-LR/1

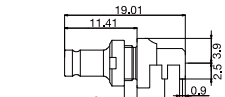

DCJ-FEM

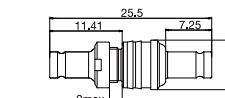

DCJ-JR

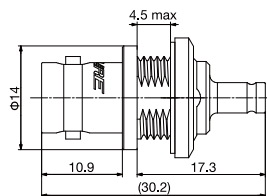

BCJ-DCJ

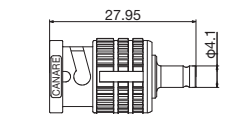

BCP-DCJ



NDT-DIN

## 75Ω Micro-miniature Coaxial Connectors

Canare's exclusive micro miniature connectors, KC series: specially designed for 4K/8K UHD equipment. Our PCB mount solutions provide flexible layout and reliable connectivity on 12G-SDI signal path. Products are 12GHz verified and guaranteed SMPTE ST2082-1.

### PCB Mount Receptacles 12G-SDI

Model	Description
KCM-PC	Straight
KCM-LR	Right Angle

Standard package: 20 pcs

### KC to BNC Conversion Adapter 12G-SDI

Model	Description	Nut Driver Bit
BCJ-KCM	Rear Mount, Hex Nut	—
BCJ-FKCM	Front Mount, Grooved Nut	NDT-7/16

Standard package: 20 pcs

**Note:** BCJ-FKCM requires the nut driver bit NDT-7/16 for installation and removal. Contact for the details.

### Cable Assemblies 12G-SDI

Model	Description	
	Plug A	Plug B
KC1.2R-***-S	Straight	Straight
KC1.2R-***-L	Right Angle	Right Angle
KC1.2R-***-SL	Straight	Right Angle

Jacket: FEP (blue)

\*\*\*: cable length (see below)

### <Ordering Information>

Length		Plug Type	
KC1.2R - 0015 - S			
0015	150 mm	S	Straight
0020	200 mm	L	Right Angle
0030	300 mm	SL	Straight to Right Angle

Custom length available. Contact for the details.

### Key Features and Benefits

- DC to 12 GHz; meets the SMPTE 2082-1 return loss requirements.  
Return loss: 26 dB @ 1.5 GHz, 20 dB @ 3 GHz, 15 dB @ 6 GHz, 10 dB @ 12 GHz
- Snap-on engaging
- Durable design; beneficial for maintenance.
- Temperature range: -40 to 85 degree C
- The best flexibility on PCB design

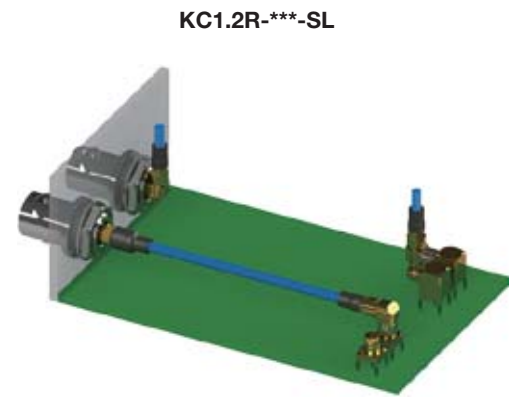
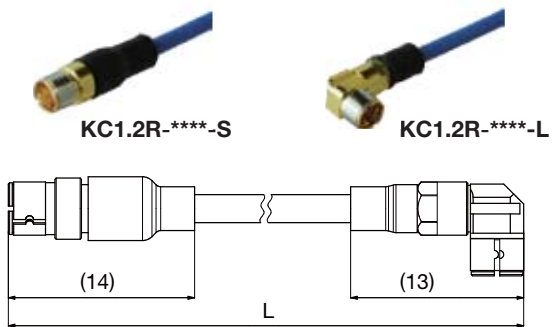
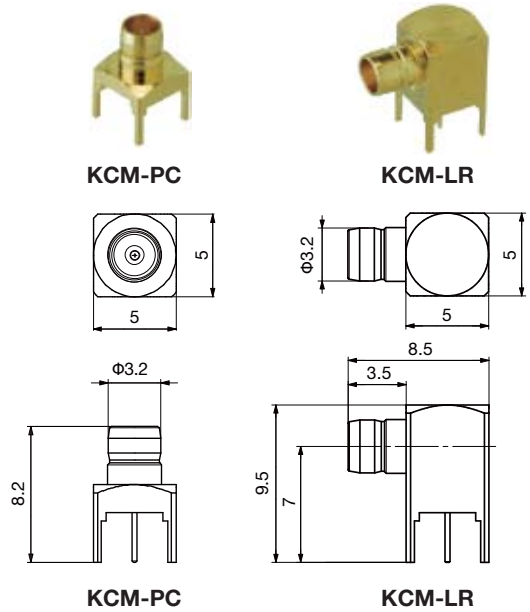
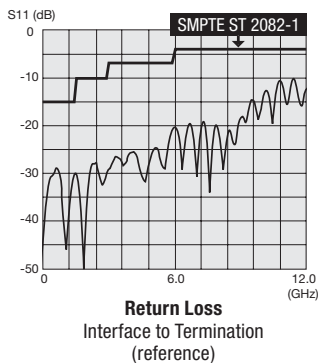

Example of Use

Technical Trend

Fiber-Optic Systems

Connectors

Cables

Panels & Patchbays

Multi-channel Systems

Cable Assemblies

# Connectors

## 75Ω Multichannel Coax Connectors

### 4K-DIN Coax Connectors

Canare unique “4K-DIN” allows you to connect or disconnect 4 of 3G-SDI signals in one easy step.

#### ■ Crimp Plugs

Return Loss: 20 dB @ 3 GHz

Model	Suitable Cable	Die Set	Description
MDM-V4C25HW	V4-2.5CHW	TCD-D253F	Male
MDF-V4C25HW	V4-2.5CHW	TCD-D253F	Female



MDM-V4C25HW

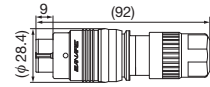

#### ■ Flush-mount Receptacle

Return Loss: 20 dB @ 3 GHz

Model	Description
MDF-V4JRU	Jack to Jack



MDF-V4C25HW

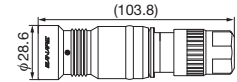

- 75Ω 4-channel coax connector with push-pull locking mechanism.
- Compact, solid, and lightweight nylon resin (PA 66) body
- Return loss: 20 dB @ 3 GHz
- MDF-V4JRU accepts MDM-V4C25HW and also DIN 1.0/2.3 plugs.

\* Replacement crimp units also available:  
DCP-C25HW-ML for MDM  
DCJ-C25HW-ML for MDF

#### <Connection Example>

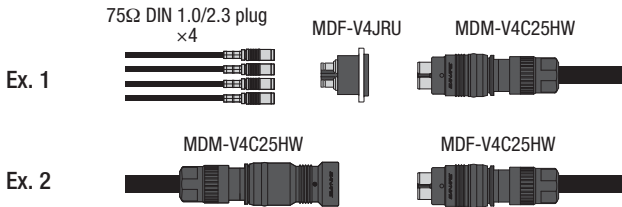

Be sure to use Canare Crimp Tool



MDF-V4JRU

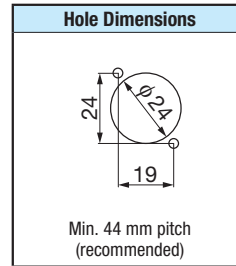
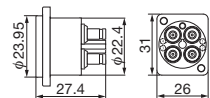

### 75Ω Multi-pin Coax Connectors

Handles five 75Ω coaxial connections.

Model	Suitable Cable	Die Set	Description
MCM-V5C3	V5-3C	TCD-35CA	Plug
MCF-V5C3	V5-3C, L-3C2V, L-3C2VS	TCD-35CA	Receptacle



MCM-V5C3



MCF-V5C3

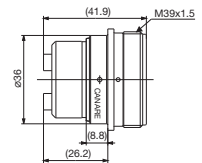
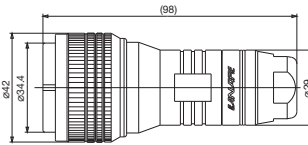

Model	Description
DCM01	Dust Cap for MCM-V5C3
DCF01	Dust Cap for MCF-V5C3

- 1.2 or less VSWR up to 1.5 GHz.
- Crimp system ensures quick and reliable installation.

\* Replacement unit also available. MCM-V5C3: BN9078A MCF-V5C3: BN9079B

Be sure to use Canare Crimp Tool

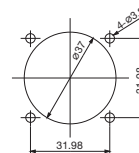

Panel Hole Dimensions  
(Mounting screw M3 x 4 pcs)

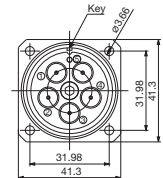

Replacement Unit BN9078A



Replacement Unit BN9079B

## 75Ω Triaxial Connectors

Canare CC series cover global triaxial interconnection. CC-F series are ideal for interconnecting European triax system and CC-K series for American triax system.

### Key Features and Benefits

- True 75Ω, DC 1.5 GHz; ≥20 dB return loss (≤1.2 VSWR)
- Push-lock mechanism
- Reliable crimp system
- Rugged and durable construction

## CC-F Series

Cable compatibility meets European interconnecting requirements.

Model	Description	Suitable Cable		Boot/Cap	Center contact	Sleeve A	Sleeve B	Crimp Tool
		Canare	Others					
CCF5-JFC	Crimp type, Female cable mount	L-5CFTX	Belden: 7783A Klotz: TRIAX8 Fujikura: 4.8/1.0 EFTXF	CB31	BN9194	BN7120	BN7121	TC-1 + TCD-65C
CCM5-PFC	Crimp type, Male cable mount			CB32	BN1135	BN7120	BN7121	
CCF5-JFRC	Crimp type, Female panel mount			DCF02	BN9194	BN7120	BN7121	
CCM5-PFRC	Crimp type, Male panel mount			DCM02	BN1135	BN7120	BN7121	
CCF7-JFC	Crimp type, Female cable mount	L-7CFTX	Belden: 7784AS Klotz: TRIAX11 Fujikura: SUPERFLEX11	CB31	BN9182A	BN7113	BN7114	TC-2 + TCD-96C
CCM7-PFC	Crimp type, Male cable mount			CB32	BN1131	BN7113	BN7114	
CCF7-JFRC	Crimp type, Female panel mount			DCF02	BN9182A	BN7113	BN7114	
CCM7-PFRC	Crimp type, Male panel mount			DCM02	BN1131	BN7113	BN7114	

Center Contact

Sleeve A

Sleeve B

Panel Hole Dimensions

VSWR for CCx7-F

## CC-K Series

Cable compatibility meets American interconnecting requirements.

Model	Description	Suitable Cable		Retrofit Kit	Boot/Cap	Crimp Tool
		Canare	Others			
CCF4-JK	Crimp type, Female cable mount	L-4CFTX	Belden: 1856A, 1857A, 9267 Gepeco: LVT61859, VT61859	BN9127A	CB23	TC-1 + TCD-316C
CCM4-PK	Crimp type, Male cable mount			BN9128B	CB22	
CCF4-JKR	Crimp type, Female panel mount			BN9127A	DCM02	
CCM4-PKR	Crimp type, Male panel mount			BN9128B	DCM03	

Panel Hole Dimensions

VSWR for CCx4-K

### RCA Pin Connectors

#### RCAP-C Series (Crimp Plugs)

Model	Suitable Cable		Center Pin	Sleeve	Boot	Die Set
	Canare	Others				
RCAP-C25F	L-2.5CFB	1855A, 8218, 1417B, 1418B	B11014E	BN7029C	—	TCD-35CA
RCAP-C25HD	L-2.5CHD	—	B11015E	BN7129	—	TCD-35CA
RCAP-C3A	L-3C2VS, L-3C2V, V*-3C	—	B11014E	BN7003A	CB24	TCD-35CA
RCAP-C3GS	GS-6	—	BN1093	BN7079	CB25	TCD-35D
RCAP-C3F	L-3CFB, V*-3CFB	—	B11015E	BN7003A	CB24	TCD-35CA
RCAP-C42	—	1505F	B11016E	BN7011	—	TCD-31C
RCAP-C4A	LV-61S	8241, 8279, RG-59B/U	B11015E	BN7015A	CB25	TCD-4CA, TCD-451CA
RCAP-C4F	L-4CFB, V*-4CFB	1505A, 1505ANH, 8212, 8241F, 9167, 9259, 9659	B11016E	BN7015A	CB25	TCD-4CA, TCD-451CA
RCAP-C53	L-4.5CHD	1694A, 9066, 9116, 9118, 9248	B11020D	BN7016	CB26	TCD-35CA
RCAP-C5A	L-5C2VS, L-5C2V, V*-5C	—	B11016E	BN7016	CB26	TCD-35CA
RCAP-C5F	L-5CFB, V*-5CFB	—	B11020D	B75004A	CB26	TCD-5CF, TCD-55FA
RCAP-C77	LV-77S	8281F	B11016E	B75004A	CB26	TCD-5CF, TCD-55FA

•Standard package (20pcs/100pcs)

- Canare crimp design ensures quick and reliable installation.
- The crimp tool for the RCAP-C can be used for the Canare crimp BNC plugs as well, thus saving on extra equipment.

Be sure to use the Canare Crimp Tool.

#### Solder Plugs

Model	Description
F-09	Plug
F-10	Plug (long sleeve)

•Standard package (10 pcs)

- Robust metal shell
- Comfortable grip
- Cable OD up to 6.0 mm.

#### Standoff Receptacle

Model	Description
RJ-JR	Jack to Jack

•Standard package: 20 pcs by insulation color

- Insulation color is available in 5 colors (red, green, blue, yellow, white).
- VSWR 1.2 @ 100 MHz

#### Flush-mount Receptacles

Model	Description	Flange Type
RJ-RU	RCA - Solder	ITT XLR-F77
RJ-RUD		Neutrik D
RJ-RUDB		Neutrik D (Black)
RJ-JRU	RCA - RCA	ITT XLR-F77
RJ-JRUD		Neutrik D
RJ-JRUDB		Neutrik D (Black)
RJ-BCJRU	RCA - BNC	ITT XLR-F77
RJ-BCJRUD		Neutrik D
RJ-BCJRUDB		Neutrik D (Black)

•Standard package: 20 pcs by insulation color

- Three types of flanges are available.
- Insulation color is available in 5 colors (red, green, blue, yellow, white).
- VSWR 1.2 @ 100 MHz

#### <Panel Hole Dimensions>

RJ-JR (*)	ITT XLR-F77 Flange	Neutrik D Flange

(\*) RJ-JR accepts insulation bushing IU-7/16; in this case, panel hole for IU-7/16 should be adopted (see page 33)



RCAP-C3A



F-09

F-10

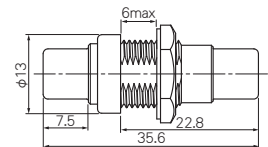

RJ-JR



RJ-RU

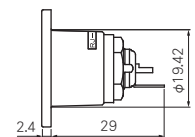

RJ-RU



RJ-RU

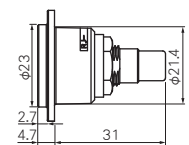

RJ-JRUD

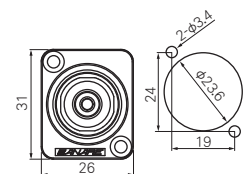

RJ-JRUD



RJ-BCJRU

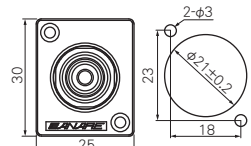
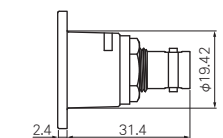

RJ-BCJRU



## F Connectors

This type is used in such applications as home television receivers for cable television (CATV) systems.

### FP-C Series (Crimp Plugs)

Model	Suitable Cable		Center Pin	Sleeve	Boot	Die Set
	Canare	Others				
FP-C25HD	L-2.5CHD	—	BN1003B	BN7129	—	TCD-35CA
FP-C3	L-3C2VS, L-3C2V, V*-3C	—	BN1002B	BN7003A	CB24	TCD-35CA
FP-C31	L-3C2W	—	BN1002B	BN7011	CB25	TCD-31C
FP-C3F	L-3CFB, V*-3CFB	—	BN1003B	BN7003A	CB24	TCD-35CA
FP-C4	LV-61S	8241, 8279, RG-59B/U	BN1003B	BN7015A	CB25	TCD-4CA, TCD-451CA
FP-C4F	L-4CFB, V*-4CFB	1505A, 1505ANH, 8212, 8241F, 9167, 9259, 9659	BN1004B	BN7015A	CB25	TCD-4CA, TCD-451CA
FP-C5	L-5C2VS, L-5C2V, V*-5C	—	BN1004B	BN7016	CB26	TCD-35CA
FP-C52	L-5C2W	—	BN1004B	BN7014	—	TCD-451CA
FP-C53A	L-4.5CHD	1694A, 9066, 9116, 9118, 9248	BN1005B	BN7046	CB26	TCD-35CA
FP-C55A	—	1695A, 89120, 87120, 633948, 9116P	BN1005B	BN7045A	—	TCD-35CA
FP-C5F	L-5CFB, V*-5CFB	—	BN1005B	B75004A	CB26	TCD-5CF, TCD-55FA
FP-C71A	—	7731A, 9064, 9292, 1617A, 9011	BN1041A	BN7021A	—	TCD-7CA
FP-C7FA	L-7CFB	—	BN1030A	BN7021A	—	TCD-7CA

•Standard package (20pcs/100pcs)

- Lock mechanism improves reliability by preventing shifting or detaching of the center pin.
- The tools and cable stripper can be used for the Canare crimp BNC plugs as well, thus saving on extra equipment.
- VSWR of 1.1 or less up to 2 GHz.
- Designed for indoor use.

Be sure to use the Canare Crimp Tool.



FP-C4

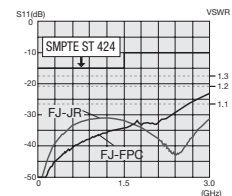

Fig.1 Return loss for FJ-FPC and FJ-JR

### Standoff Receptacle

Model	Description
FJ-JR	Jack to Jack
FJ-FPC	PC Board Straight Mount

•Standard package (20pcs/100pcs)

- VSWR of 1.1 or less up to 2 GHz. <Fig. 1>
- Accept insulation bushing IU-7/16. See page 33 for more information.

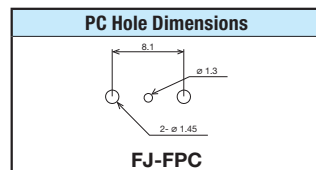
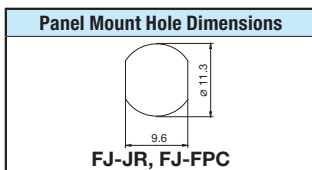

FJ-JR



FJ-FPC



FJ-JRU

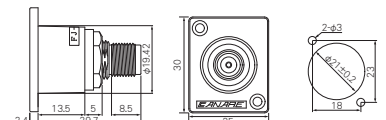

FJ-JRU

### Flush-mount Receptacles

Model	Description	Flange Type
FJ-JRU	Jack to Jack	ITT XLR-F77
FJ-JRUD		Neutrik D
FJ-JRUDB		Neutrik D (Black)

•Standard package: 20 pcs

- Three types of flanges are available.



FJ-JRUD

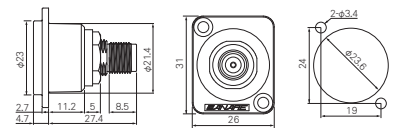

FJ-JRUD

### Phone Plugs

Model	Description
F-11	3.5 mm Mini Phone TS
F-12	3.5 mm Mini Phone TRS
F-15	6.3 mm (1/4") TS Phone
F-16	6.3 mm (1/4") TRS Phone

•Standard package (10pcs)

- Featuring a properly cable cramp system ensures long life reliability.
- Suited to cables up to 6.0 mm in outer diameter.

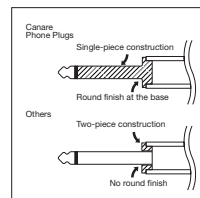

Canare's durable design



F-11

F-12

F-15

F-16

# Connectors

## 50Ω BNC Connectors

### 50Ω BNC Crimp Plugs

VSWR of 1.1 or less up to 2 GHz, 1.2 or less up to 4 GHz.

#### BP-C Series

Model	Suitable Cable	Center Pin	Sleeve	Boot	Die Set
BP-C3	L-3D2V, 3D-2V	BN1023A	BN7003A	CB03	TCD-35D
BP-C31	L-3D2W, 3D-2W	BN1023A	BN7011	CB04	TCD-3151D
BP-C4	RG-58C/U, RG-58A/U	BN1024A	BN7030A	CB03	TCD-35D
BP-C5	L-5D2V, 5D-2V	BN1025B	BN7016	CB05A	TCD-35D
BP-C51	L-5D2W, 5D-2W	BN1025B	BN7002	—	TCD-3151D
BP-C5FA	L-5DFB, 5D-FB	BN1016C	B75004A	CB05A	TCD-35DF
BP-C51F	L-5DFBW-PE	BN1016C	BN7002	—	TCD-55FA

•Standard package (20pcs)



BP-C5

#### BP-LC Series (Right Angle Type)

Model	Suitable Cable	Center Pin	Sleeve	Die Set
BP-LC31	L-3D2W, 3D-2W	BN1023A	BN7011	TCD-3151D
BP-LC51	L-5D2W, 5D-2W	BN1025B	BN7002	

•Standard package (20pcs)



BP-LC31

- Lock mechanism used on insulation improves reliability by preventing shifting or detaching of the contact pins.
- Elongated body design for straight type enables easy attachment and removal.
- Gold plating on the contact pin prevents deterioration, even after years of use.
- Use of crimping to attach the connectors ensures quick, reliable installation.

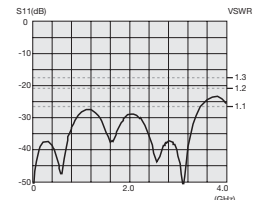

Return loss for BP-C31

Be sure to use the Canare Crimp Tool.

### 50Ω BNC Receptacles

#### Standoff

Model	Description
BJ-JR	Jack to Jack

•Standard package (20pcs)

- Mounting hole size is same as that for BCJ-R/1 connector.



BJ-JR

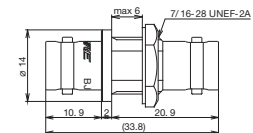

BJ-JR

#### Flush-mount Receptacles

Model	Description	Flange Type
BJ-JRU	Jack to Jack	ITT XLR-F77
BJ-JRUD		Neutrik D

•Standard package (20pcs)

- Two types of flanges are available.
- Flush-mount receptacle prevents damage on the jack.



BJ-JRU

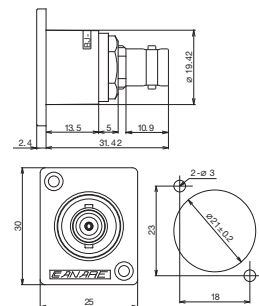

BJ-JRU

### 50Ω BNC Extension Adapter

Model	Description
BJ-J	Jack to Jack

•Standard package (20pcs)

- VSWR of 1.1 or less up to 4 GHz.



BJ-J

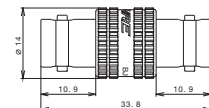

BJ-J

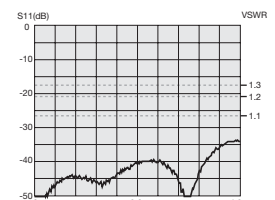

Return loss for BJ-J

## 50Ω TNC Crimp Plugs

### TNP-C Series

Model	Suitable Cable	Boot	Die Set
TNP-C3	L-3D2V, 3D-2V	CB03	TCD-35D
TNP-C31	L-3D2W, 3D-2W	CB04	TCD-3151D
TNP-C4	RG-58C/U, RG-58A/U	CB03	TCD-35D
TNP-C5	L-5D2V, 5D-2V	CB05A	TCD-3151D
TNP-C51	L-5D2W, 5D-2W	—	TCD-3151D
TNP-C5F	L-5DFB, 5D-FB	CB05A	TCD-35DF TCD-55FA

•Standard package (20pcs)

### TNP-LC Series (Right Angle Type)

Model	Suitable Cable	Die Set
TNP-LC31	L-3D2W, 3D-2W	TCD-3151D
TNP-LC51	L-5D2W, 5D-2W	

•Standard package (20pcs)

- VSWR of 1.1 or less up to 2 GHz, 1.2 or less up to 4 GHz.
- Use of crimping to attach the connectors ensures quick, reliable installation.
- Crimping tool can be used for the Canare crimp BNC plugs as well, thus saving on extra equipment.
- Elongated body design for straight type enables easy attachment and removal.

Be sure to use the Canare Crimp Tool.



TNP-C3

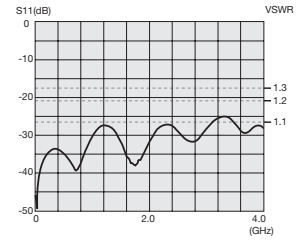

Return loss for TNP-C3



NP-C51

## 50Ω N Crimp Plugs

### NP-C Series

Model	Suitable Cable	Boot	Die Set
NP-C31	L-3D2W, 3D-2W	CB04	TCD-3151D
NP-C51	L-5D2W, 5D-2W	—	
NP-C5F	L-5DFB, 5D-FB	CB05A	TCD-35DF
NP-C51F	L-5DFBW-PE	—	TCD-55FA

•Standard package (20pcs)

### NP-LC Series (Right Angle Type)

Model	Suitable Cable	Die Set
NP-LC31	L-3D2W, 3D-2W	TCD-3151D
NP-LC51	L-5D2W, 5D-2W	

•Standard package (20pcs)

- VSWR of 1.1 or less up to 2 GHz, 1.2 or less up to 4 GHz.
- Lock mechanism used on insulation prevents shifting or detaching of the contact pins.
- Use of crimping to attach the connectors ensures quick, reliable installation.

Be sure to use the Canare Crimp Tool.



NP-LC31

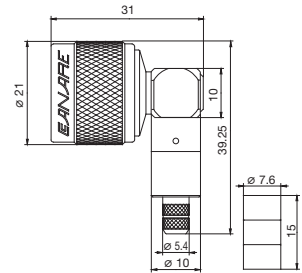

NP-LC31

## 50Ω SMA Crimp Plugs

### SMAP-C Series

Model	Suitable Cable	Die Set
SMAP-C1	L-5D-QEW	TCD-1DB
SMAP-C3F	L-3DFB	TCD-35DF
SMAP-C31A	L-3D2W, 3D-2W	TCD-3151D
SMAP-C51	L-5D2W, 5D-2W	
SMAP-C5F	L-5DFB, 5D-FB	TCD-35DF TCD-55FA

•Standard package (20pcs)

### SMAJ-C Series

Model	Suitable Cable	Die Set
SMAJ-C3F	L-3DFB	TCD-35DF
SMAJ-C51	L-5D2W, 5D-2W	TCD-3151D
SMAJ-C5F	L-5DFB, 5D-FB	TCD-35DF TCD-55FA

•Standard package (20pcs)

- Center contact for SMAP-C1 is of solder type.
- VSWR of 1.1 or less up to 2 GHz, 1.2 or less up to 4 GHz. (SMAP-C1: VSWR of 1.2 or less up to 2 GHz.)

Be sure to use the Canare Crimp Tool.



SMAP-C1

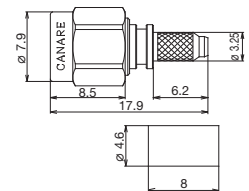

SMAP-C1



SMAP-C31A

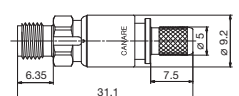

SMAJ-C3F



SMAJ-C3F

# Connectors

## //// Cable Stripper, Crimp Tools

### Coaxial Cable Stripper

Three internal circular steel blades perform precise, extremely clean and easy stripping.

Model	Preset to
<b>TS100E</b>	LV-77S-L-5CFB, V*-5CFB, V*-5C, LV-61S-L-4CFB, V*-3C
<b>TS100U</b>	L-2.5CHD, 1855A, 1505A, 1694A

- For most Canare BNC, DIN, RCA and F crimp plugs.
- Rotary knob to select 5 different cable setups.
- Make your own cable setting within cable O.D. 4mm~11mm
- Hex wrench is attached on the lid top for quick adjustment.
- One replacement blade included, and also sold separately.  
Replacement blade: TSC (1 pc)

#### Note:

The following types of cables may not be accurately processed by Canare's TS100 Cable Stripper, owing to their construction.

1. Cables employing such hard jacket material as polyethylene.
2. Cables employing such particularly soft insulator material as high-foam polyethylene.
3. Cables employing steel wire and semirigid pipe for outer conductor.



TS100E

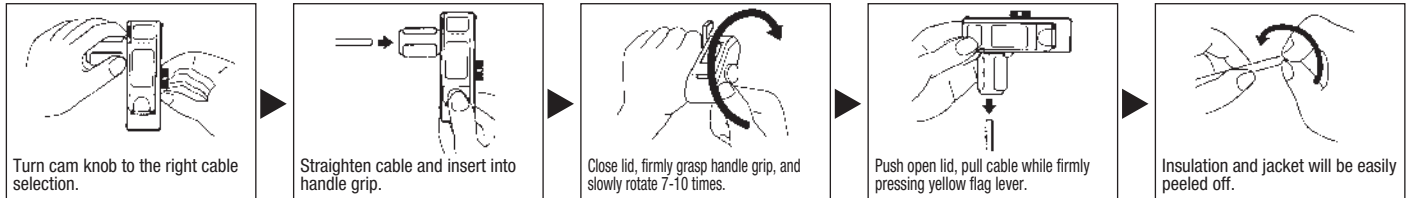
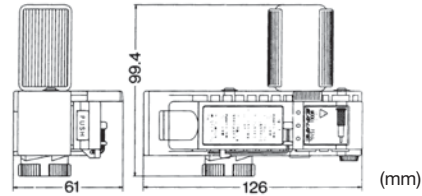

### Crimp Tools

Canare crimp tool offers reliable high-quality crimping performance in an easy-to-use design.

#### ■ Die Sets    ■ Hand Crimp Tools

Model	Model
TCD-1DB	TC-1
TCD-31C	
TCD-3151D	
TCD-316C	
TCD-35CA	
TCD-35D	
TCD-35DF	
TCD-4CA	
TCD-451CA	
TCD-5CF	
TCD-5HD	
TCD-55FA	
TCD-55UHD	
TCD-57C	
TCD-65C	
TCD-67HD	
TCD-7CA	
TCD-8HD	TC-2
TCD-96C	TC-1
TCD-D253F	
TCD-D534F	

- Select the appropriate die set to suit the individual connector
- Hand crimp tool is required for die set, and sold separately
- Die set are interchangeable



TC-1

#### ■ Accessories

Model	Description	Length
TB-2A	Tool case	—
BET-12	Extraction tool for BNC straight plug	12 inch
BET-MBNC	Extraction tool for MBNC-C series	30 cm
BET-DIN	Insertion / extraction tool for DCP-C series	30 cm



TB-2A  
(tools and connectors not included)



BET-12

BET-MBNC

BET-DIN



## Crimp Connector Assembly Instructions

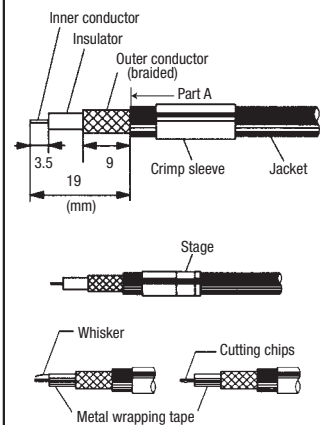

### Confirm compatibility of the connector and cable prior to assembly.

- Slide the crimp sleeve over the cable and strip the jacket, braided shield, and insulation of the coaxial cable as shown at left.
  - For cables with stranded inner conductor, twist the strands in the same direction as plied after removing the insulation.
  - For a crimp sleeve with steps, slip it over the cable from the stepped end, as in the diagram.
  - If any metal foil shield is left on the cable, it may get stuck in the mouth of connector, making insertion impossible.
  - Remove all stray strands and offcuts of the metal foil shield to avoid possible short circuiting.
  - Make sure the inner conductor is free of all insulation debris and offcuts to ensure complete crimping.

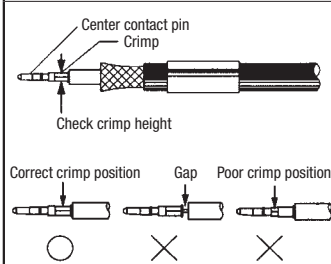

- Place the center contact pin of the connector on the inner conductor of the cable and crimp the center contact pin at the correct position (without remaining a gap) as shown at left, using the specified crimp tool and die set.
  - To confirm the crimping properly, measure the crimp height after removing burrs with a knife. If it is not within the ideal value range, adjust the crimp tool.
  - Do not crimp the center contact pin at the stepped root end.
  - Confirm the center contact pin is crimped straight to the inner conductor. If the center contact pin is slanted, align it gently.



- Hold the cable and push it into the connector body until the center contact is locked in place. You may feel a click sound when the center contact pin is locked.
  - Pull the cable gently (less than 4.5 lbs or 19.6 N) to confirm that it is locked.

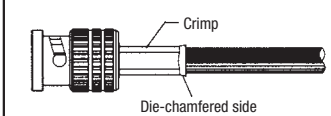

- Slide crimp sleeve up against connector body over the braided shield until it butts against the connector body. Center the die over the crimp sleeve and crimp in place, using the specified crimp tool and die set.
  - Do not pull the cable while crimping is executed.

## Adjusting Crimp Tool

### 1. Measuring Crimping height

Crimp height is measured after the crimp is made. As shown in the figure, the sum of the measured values for both directions is divided by two to arrive at the crimp height. The ideal value range for the BCP-A3 connector, for example, is 1.4 mm to 1.5 mm. When this value is lower (overcrimping occurs) than the recommended crimp height, the crimp becomes very hard. A value higher (undercrimping occurs) than the recommended value can result in increased electrical resistance and a physically weaker crimp. Either digital calipers or a micrometer should be used for measuring crimp height.

### 2. Measuring Frequency

Crimp height is measured prior to commencing use of the crimp tool and always when changing the crimping die. After this, the crimp height is regularly measured after about each 1,000 crimps.

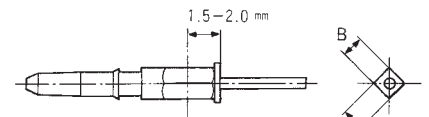

$$\text{Crimp height value} = (A+B) / 2$$

Refer to the separately included manual for the appropriate crimp height values for individual connectors.

### 3. Tool Measuring Procedures

Crimp force increases and crimp height decreases when the tool's adjuster dial is turned in the direction of the 9. The dial is adjusted by first releasing it using a screw driver.



## FAQ

**Q** Does it matter in which direction crimp sleeves are attached?

**A** For BCP-A3—use and other non-stepped (straight type) crimp sleeves, it does not matter in which direction the crimp sleeve is attached. The attachment direction also does not matter for BCP-A5F—use and other specific-use types that have a chamfer (groove) at one end of the crimp sleeve.

However, stepped crimp sleeves such as those for BCP-C1, etc. are directional and must be attached in the direction shown in the diagram below, with the cable threaded through the sleeve starting from the end with the step (that is, the end with smaller-diameter hole).



**Q** What should be done with a metal foil shield?

**A** Strip the metal foil shield to the root of the braided shield (to the edge of the jacket).

If any metal foil shield is left on the cable, it may get stuck in the mouth of connector, making insertion impossible.

**Q** Why do some BNC plugs made by other companies have a sharp point at the tip of the central contact? Are these compatible with Canare's BNC receptacles?

**A** The central contact is pointed in conformance with the JIS standard for 50 Ω BNC connectors. The central contacts on Canare's connectors conform to the MIL standard, and therefore are not pointed. These two different shapes simply offer different ways to guide the plug into the female receptacle and have no direct effect on contact quality.

The actual contact surfaces on Canare's BNC connectors are designed in conformance with JIS standards and therefore pose no compatibility problems.

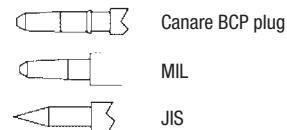

**Q** Is it possible to use cables not listed in the connector compatibility table as long as they are close to the dimensions of those listed?

**A** No. While connection may be possible, performance may be adversely affected.

Even if the connection appears to work, factors such as electrical instability, weak cable contact strength and others may cause problems during actual use.

Therefore, it is necessary to test and evaluate whether it is actually possible to use the configuration in question. Particular caution should be used when crimping is involved.

**Q** What is meant by "cable contact strength"?

**A** Cable contact strength refers to the maximum load borne by the cable when exerting tensile force to remove it from the connector. For Canare products, "cable contact strength" refers to the contact strength of a cable's outer conductor, not including the pull-out strength of the central contact or the contact strength of the inner conductor.

**Q** What is the approximate insertion loss associated with connectors?

**A** The value varies depending on the connector, but for BNC plugs, the value is approximately 0.1 dB per plug (DC–2 GHz).



### Cables to Connector Cross-Reference

#### ■ BNC, F, RCA, etc.

See page 47, for more information about the crimp height.

Model	BNC				Jack	F	RCA	Others	Suitable Die Set	Crimp Height		
	Crimp Plug											
	BCP-D/B	BCP-A/C	BCP-LC	MBCP-C		FP-C	RCAP-C					
L-1.5C2VS/V*-1.5C												
1.5C-2V		BCP-C1			BCJ-FC1(-7/16) BCJ-RUC1				TCD-1DB	—		
L-2.5C2V		BCP-A25							TCD-35CA	1.40 - 1.47		
L-2.5CFB		BCP-A25F		MBCP-C25F			RCAP-C25F					
1855A	BCP-B26											
1855P												
L-2.5CHD/L-2.5CHLT	BCP-B25HD					FP-C25HD	RCAP-C25HD					
VDM230												
1855ENH	BCP-B28											
HD PRO 0.6/2.8 AF												
1506A		BCP-A32										
L-2.5CHWS	BCP-B25HW							MCVP-C25HW		TCD-D253F	1.08 - 1.16	
V4-2.5CHW												
L-3C2V/L-3C2VS		BCP-A3	BCP-LC3					MCM-V5C3 MCF-V5C3	TCD-35CA	1.40 - 1.50		
V3-3C/V4-3C		BCP-A3 BCP-VA3				FP-C3	RCAP-C3A					
V5-3C								MCM-V5C3 MCF-V5C3				
L-3CFB	BCP-B3F	BCP-A3F	BCP-LC3F	MBCP-C3F		FP-C3F	RCAP-C3F					
V*-3CFB												
L-3.3CUHD	BCP-D33UHD											
1695A		BCP-A55				FP-C55A						
VSD2001TS												
L-3C2W		BCP-A31				FP-C31					TCD-31C	
L-3CFW	BCP-B31F											
V*-3CFW												
LV-61S		BCP-A4		MBCP-C4	BCJ-C4	FP-C4	RCAP-C4A	VWP-C4A MVP-C4	TCD-4CA or TCD-451CA	1.40 - 1.50		
RG-59B/U												
L-4CFB/V*-4CFB		BCP-A4F		MBCP-C4F		FP-C4F	RCAP-C4F					
1505A, 1505ANH	BCP-B4F											
HD PRO 0.8/3.7 AF												
VPM2000												
L-4CHD												
1505F		BCP-A42					RCAP-C42		TCD-31C			
L-4.5CHD	BCP-B53			MBCP-C53		FP-C53A	RCAP-C53		TCD-35CA			
1694A												
HD PRO 1.0/4.8 AF	BCP-B56											
L-4.5CHWS	BCP-B45HW											
L-5C2V/L-5C2VS		BCP-A5	BCP-LC5									
V*-5C		BCP-A5 BCP-VA5				FP-C5	RCAP-C5A					
LV-77S		BCP-A77						RCAP-C77				
L-5CFB	BCP-B5F	BCP-A5F	BCP-LC5F	MBCP-C5F		FP-C5F	RCAP-C5F		TCD-5CF or TCD-55FA excluding BCP-A5F (*2)			
V*-5CFB		(*1)										
L-5CFW	BCP-B51F											
V*-5CFW												
8281F		BCP-A77					RCAP-C77					
L-5C2W		BCP-A52				FP-C52			TCD-451CA			
L-5CHD		BCP-C5HD							TCD-5HD	1.90 - 2.00		
L-5.5CUHD	BCP-D55UHD								TCD-55UHD	1.62 - 1.72		
4794R	BCP-D57								TCD-57C			
L-6CHD		BCP-C6HD							TCD-67HD	2.15 - 2.25		
L-7CHD		BCP-C7HD										
L-7CFB		BCP-C7FA				FP-C7FA						
7731A		BCP-C71A							TCD-7CA	1.90 - 2.00		
9292						FP-C71A						
L-8CHD		BCP-C8HD							TCD-8HD	2.44 - 2.54		
GS-6							RCAP-C3GS		TCD-35D	2.01 - 2.20		

#### ■ DIN 1.0/2.3, 4K-DIN

Model	DIN DCP-C	4K-DIN MD	Suitable Die Set	Crimp height
L-2.5CHD/L-2.5CHLT	DCP-C25HD		TCD-D253F	1.08 - 1.16
1855A				
VDM230				
L-2.5CHWS	DCP-C25HW		TCD-D534F	1.25 - 1.33
V4-2.5CHW		MDM-V4C25HW MDF-V4C25HW		
L-3CFB	DCP-C3F			
L-4CFB	DCP-C4F			
1505A				
VPM2000				
L-4CHD				
L-4.5CHD	DCP-C53			
1694A				
VSD2001				

\*1: Suitable die set for BCP-A5F is TCD-35CA

See page 44-45, for 50 ohm cables and connectors.

Belden: 1505A, 1505ANH, 1505F, 1506A, 1694A, 1695A, 1855A, 1855ENH, 1855P, 4794R, 7731A, 8281F, 9292

Draka: HD PRO 0.6/2.8 AF, HD PRO 0.8/3.7 AF, HD PRO 1.0/4.8 AF

Gecco: VDM230, VPM2000, VSD2001, VSD2001TS

Note: Be sure to use the right combination of cable, connector and die set for proper connection

## 110Ω-75Ω Impedance Transformers

Passively convert AES/EBU digital audio signals from 110Ω/XLR3 output to a 75Ω BNC coaxial cable and then back again to a 110Ω/XLR3 input.

### Adapter Type

Model	Description
BCJ-XJ-TRC	XLR3 (F) - BNC Jack
BCJ-XP-TRC	XLR3 (M) - BNC Jack
BCJ-XJ-A10TRC	XLR3 (F) - BNC Jack, 10dB Attenuation Pad

### Panel Mount Type

Model	Description (Front - Back)	Flange Type
XJ3F-TRC-BCJ	XLR3 (F) - BNC Jack	ITT XLR-F77
XJ3M-TRC-BCJ	XLR3 (M) - BNC Jack	
BCJ-TRC-XP3F	BNC Jack - XLR (F)	
BCJ-TRC-XP3M	BNC Jack - XLR (M)	
XJ3F-A10TRC-BCJ	XLR3 (F) - BNC Jack, 10dB Attenuation Pad	
BCJ-A10TRC-XP3F	BNC Jack - XLR3 (F), 10dB Attenuation Pad	

- SMPTE 276M and AES3 transmission standards
- Coaxial transmission of 2 channel digital audio
- Allows longer cable runs than 110 ohm twisted pair
- AES/EBU signal distribution using Canare 75 ohm video patchbays

#### BCJ-XJ-TRC / BCJ-XP-TRC

75Ω BNC (unbalanced)      110Ω XLR3 (balanced)

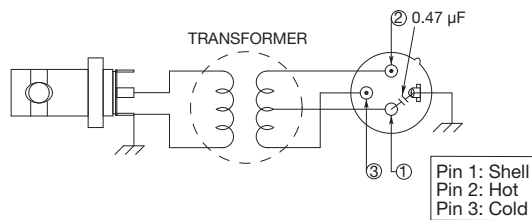

#### BCJ-XJ-A10TRC

75Ω BNC (unbalanced)      110Ω XLR3 (balanced)

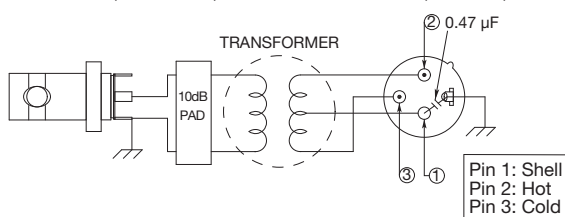

### 110Ω-75Ω Impedance Transformer: Input/Output Level Performance

AES/EBU Transmitter (V)	Transformer Out (V)
2.0	1.60
3.0	2.39
4.0	3.18
4.5	3.60
5.0	3.98
6.0	4.78
7.0	5.58
8.0	6.38
9.0	7.18
10.0	7.98

BCJ-XJ-TRC/BCJ-XP-TRC

AES/EBU Transmitter (V)	Transformer Out -10dB Pad (V)
2.0	0.50
3.0	0.75
4.0	1.01
4.5	1.13
5.0	1.26
6.0	1.51
7.0	1.76
8.0	2.02
9.0	2.27
10.0	2.52

BCJ-XJ-A10TRC



BCJ-XJ-TRC



BCJ-XP-TRC



BCJ-XJ-A10TRC



XJ3F-TRC-BCJ



BCJ-TRC-XP3M

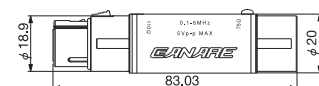

BCJ-XJ-TRC

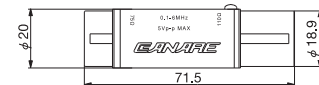

BCJ-XP-TRC

Panel Hole Dimensions

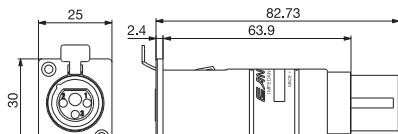
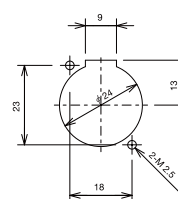

XJ3F-TRC-BCJ

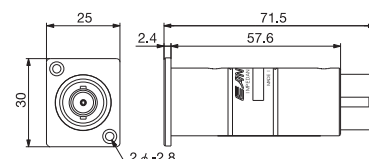

BCJ-TRC-XP3M