

Operating and Assembly Instructions

Electromagnet tooth clutch

Type 546.xx

Stator design 3 and design 4

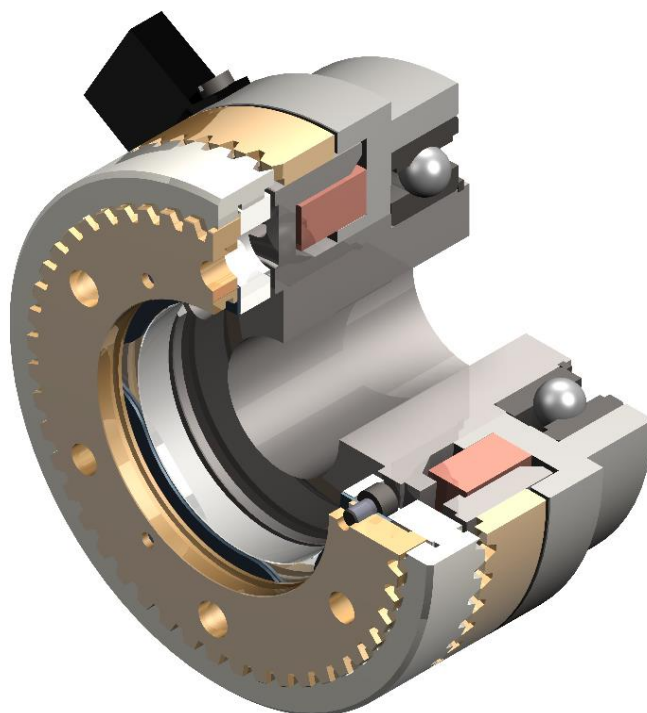

Doc-ID: T24.0106_e

as of: 12/2018

**Read these operating instructions
before starting any kind of work!**

Contents

1. General	4
1.1. Information about these instructions	4
1.2. Explanation of symbols	5
1.3. Limitation of liability	7
1.4. Copyright protection	8
1.5. Spare parts	8
1.6. Guarantee conditions	8
1.7. Customer service	9
1.8. Declaration of Incorporation	10
2. Safety	11
2.1. General	11
2.2. Personnel requirements	12
2.2.1. Qualifications	12
2.2.2. Unauthorized persons	13
2.3. Intended use	13
2.4. Technical modifications	14
2.5. Personal protective equipment	14
2.6. Specific dangers	14
2.7. Safety devices	16
2.8. Signs	16
3. Technical Specifications	17
3.1. Connection dimensions, connection fixings	17
4. Setup and method of function	18
4.1. Setup	18
4.1.1. Individual parts view	18
4.1.2. Depiction of the different armature ring designs	19
4.2. Description	20
4.2.1. Features	20
4.3. Functional method	20
5. Transport, packaging and storage	21
5.1. Safety instructions for transport	21
5.2. Transport inspection	22
5.3. Packaging	22
5.4. Removing from the packaging	23
5.5. Storing the packaged items	23
6. Installation	23
6.1. Safety	23

6.2.	Preparation	25
6.3.	Assembly	25
7.	Startup	33
8.	Operation	34
8.1.	General	34
8.2.	Recommendations for operation	34
9.	Faults	36
9.1.	Safety	36
9.2.	Malfunctions	38
10.	Maintenance	40
10.1.	Wear checking	40
10.2.	Safety	41
10.3.	Dismantling	41
10.4.	Disposal	41
11.	Applicable standards, guidelines and regulations	42

1. General

1.1. Information about these instructions

These instructions enable safe and efficient handling of the Electromagnet tooth clutch, type 546.xx, design 3 and design 4, hereinafter referred to as clutch.

These instructions are part of the clutch system and must be kept in the immediate vicinity of the location, where the clutch is used and be accessible to staff at all times. Staff must read and understand these instructions carefully before beginning any work. Compliance with all safety instructions stated in these instructions constitute the basic requirement for safe working practices.









In addition, local accident prevention regulations and general safety rules apply to the range of application of the combination.

1.2. Explanation of symbols

Warnings

All warnings in these operating instructions will be indicated by a warning symbol.

The following warning symbols are used throughout these operating instructions:

Symbol	Meaning
	Danger to persons with heart pacemakers
	General warning
	Danger from electric current
	Danger of crushing!
	Danger from hot surfaces
	Warning of magnetic field
	Danger of environmental pollution
	General instructions and useful suggestions on handling

Safety precautions

The safety instructions are indicated in these instructions by symbols. The safety instructions are introduced by signal words that are intended to indicate the extent of the danger.

The warning symbol also indicates the type of danger.

The following warnings are used throughout these instructions:

	⚠ DANGER
	<p>Danger to life</p> <p>Consequences upon non-observance of the instructions...</p> <p>► In order to avoid...</p>

A warning of this category indicates an impending dangerous situation.

If the dangerous situation is not avoided, it may lead to serious injury or even death.

Follow the instructions in this warning to avoid possible danger of serious injury or even death.

	⚠WARNING
	<p>Risk of injury!</p> <p>Consequences upon non-observance of the instructions...</p> <p>▶ In order to avoid...</p>

A warning of this category indicates a potentially dangerous situation.

If the dangerous situation is not avoided, it may lead to serious injury or even death.

Follow the instructions in this warning to avoid the danger of serious injury to persons or even death.

	⚠CAUTION
	<p>Injury to persons due to...!</p> <p>Consequences upon non-observance of the instructions...</p> <p>▶ In order to avoid...</p>

A warning of this category indicates a potentially dangerous situation.

If the dangerous situation is not avoided, it may lead to light or minor injuries.

Follow the instructions in this warning to avoid the danger of serious injury to persons.

	ATTENTION
	<p>Damage to property due to...</p> <p>Consequences upon non-observance of the instructions...</p> <p>▶ In order to avoid...</p>

A warning of this category indicates potential danger to property.

If the situation is not avoided, it may lead to damage of the property.

Follow the instructions in this warning to avoid damage of the property.

Tips and recommendations

	NOTE
	Descriptive text...

A descriptive text contains additional information that is important for further processing or for simplifying the procedure step explained above.

Special safety instructions

In order to draw attention to special dangers, specific symbols were used in the safety instructions:

	⚠ DANGER
	<p>Danger due to electric current!</p> <p>Consequences upon non-observance of the instructions...</p> <p>▶ In order to avoid...</p>

	⚠ DANGER
	<p>Danger to persons with heart pacemakers!</p> <p>Consequences upon non-observance of the instructions...</p> <p>▶ In order to avoid...</p>

1.3. Limitation of liability

All specifications and notes in these instructions were compiled according to all standards and regulations, the current state of technology and many years of knowledge and experience.

The manufacturer assumes no liability for damages resulting from:

- Upon non-observance of the instructions
- Use for the non-intended purpose
- Deployment of insufficiently qualified staff
- Unauthorized modifications
- Technical modifications
- Use of non-approved spare parts

The responsibilities as agreed in the delivery contract, the general terms and conditions, the delivery conditions specified by the manufacturer as well as the applicable statutory regulations apply.

We reserve the right to make technical modifications resulting from improvements and further development.

1.4. Copyright protection

This documentation is protected by copyright.

The contents and instructions are for internal use only and may not be transferred to a third party, reproduced in any form or manner, either in whole or in part, utilized or communicated without the written permission of the manufacturer.

Infringement obligates damage compensation. We reserve the right to impose further claims.

1.5. Spare parts

	▲WARNING
	<p>Danger of injury due to wrong or faulty spare parts!</p> <p>Incorrect or defective replacement parts can lead to injury, damage, malfunction or total breakdown.</p> <ul style="list-style-type: none"> ▶ Use original spare parts from the manufacturer only.

	NOTE
	<p>The use of spare parts other than original Mönninghoff spare parts or use of spare parts not purchased directly from Maschinenfabrik Mönninghoff GmbH & Co. KG invalidates all commitments of Maschinenfabrik Mönninghoff GmbH & Co. KG or its dealers such as guarantee, service contracts etc. without prior notice.</p> <ul style="list-style-type: none"> ▶ Obtain spare parts from authorized dealers or directly from the manufacturer. See page 9 for the address.

1.6. Guarantee conditions

The guarantee conditions are included in the general terms and conditions of the manufacturer.

1.7. Customer service

Technical information is available from our customer service department

Maschinenfabrik Mönninghoff GmbH & Co. KG

Bessemerstraße 100

Postfach 101749

D – 44793 Bochum

D – 44717 Bochum

Tel.: +49 (0) 234 3335-0

E-Mail: service@moenninghoff.de

Internet: www.moenninghoff.de

Moreover, our employees are always interested in new information and experiences, which result from the use of our products or can lead to the improvement of our products.

1.8. Declaration of Incorporation

Declaration of Incorporation
according to **EC Machine Directive 2006/42/EC,**
Annex II B

Name of the manufacturer: **Maschinenfabrik Mönninghoff GmbH & Co. KG** ;
Address of the manufacturer: **Maschinenfabrik Mönninghoff GmbH & Co. KG** ;
Bessemerstrasse 100
D - 44793 Bochum

We hereby declare that the product

Model: Electromagnet tooth clutch
Type 546.xx design 3 and design 4

are intended for installing into a system/machine. Startup is not permitted until it is determined that the system/machine, in which this electromagnet tooth clutch is installed, complies with the requirements of the EC directives.

The following harmonized standards were applied:

- IEC 204-1 Electrical equipment of machines – General requirements
- DIN EN 60204-1 Safety of machines - electrical equipment of machines - part 1: general requirements
- DIN EN ISO 12100-1 Safety of machines - basic terms, general principles of design - part 1: basic terminology, methodology
- DIN EN ISO 12100-2 Safety of machines - basic terms, general principles of design - part 2: technical principles

Full technical documentation is available.

The corresponding operating instructions for the machine/machine part are available.

- in their original version and
- in the national language of the user in their original version and in the national language of the user

Bochum,
21.09.2018

Signature..... 
Managing director: Dipl.-Kfm. Bodo Finger

2. Safety

2.1. General

This section provides an overview on all safety aspects for optimum protection of staff during assembly and startup as well as safe and trouble-free operation.

Danger due to electric current

	⚠ DANGER
	<p>Danger due to electric current</p> <p>Contact with electrically live parts can lead to fatal injuries.</p> <ul style="list-style-type: none"> ▶ Do not touch electrically live parts. ▶ When working on/with the clutch, switch off the power and secure against switching on again ▶ Pay attention to the safety instructions

Danger due to failure to observe the safety instructions!

	⚠ DANGER
	<p>Danger due to failure to observe the safety instructions!</p> <p>Failure to observe the safety and instructions listed in these assembly instructions can lead to considerable danger.</p> <ul style="list-style-type: none"> ▶ Always pay attention to all warnings and instructions specified here.

Danger due to magnetic fields

	⚠ DANGER
	<p>Danger to life of persons with heart pacemakers!</p> <p>The magnetic field of the electromagnetic tooth clutch can impair the function of heart pacemakers if the minimum distance for the pacemaker is not observed.</p> <ul style="list-style-type: none"> ▶ Persons with heart pacemakers may not work with the electromagnetic tooth clutch. ▶ Observe the regulations of BGV B11.

2.2. Personnel requirements

2.2.1. Qualifications

	⚠ WARNING
	<p>Risk of injury due to insufficient qualification!</p> <p>Improper use can result in considerable damage to persons or property.</p> <p>▶ All activities shall only be performed by qualified staff.</p>

The following qualifications are stated in the operating instructions for various different fields of activities.

- **Instructed person**
was given instruction by the operator on his/her assigned tasks and possible dangers resulting from improper conduct.
- **Specialist staff**
is able to carry out assigned work tasks as well as recognize and prevent possible dangers based on his/her technical training, knowledge and experience, including knowledge of applicable regulations.
- **Qualified electrician**
is able to carry out assigned work tasks on electrical systems as well as recognize and prevent possible dangers based on his/her technical training, knowledge and experience, including knowledge of applicable standards and regulations.
The qualified electrician was trained for his/her specific location and is familiar with the relevant standards and regulations. Only those staff members are permitted, who can be expected to reliably perform their task. Those staff members whose responsiveness is affected by substances such as drugs, alcohol or medication shall not be permitted.

	NOTE
	<p>Observe all age and occupational regulations at the location of the electromagnetic tooth clutch when selecting staff!</p>

2.2.2. Unauthorized persons

⚠WARNING	
	<p>Danger due to unauthorized persons!</p> <p>Unauthorized persons who do not fulfil the requirements described here, are not familiar with the dangers in the work area.</p> <ul style="list-style-type: none"> ▶ Do not permit unauthorized persons to be in the vicinity of the work area. ▶ In case of doubt, approach the persons and instruct them to leave the work area. ▶ Interrupt all work as long as the unauthorized person is in the work area.

2.3. Intended use

The clutch was conceived and constructed for exclusive use in frictional connection of shafts and drive flanges.

The clutch may only be used according to the technical data and operating conditions defined by the manufacturer and DIN VDE 0580.

- No potentially explosive or aggressive atmosphere
- Ambient temperature - 30°C to +60°C

⚠WARNING	
	<p>Danger due to use for other than the intended purpose!</p> <p>Any use other than for the intended purpose of the combination can lead to dangerous situations.</p> <ul style="list-style-type: none"> ▶ Only use the clutch for its intended purpose. ▶ All information contained in these operating instructions must be strictly complied with.

The operator is liable for all damage caused from use for other than the intended purpose.

2.4. Technical modifications

NOTE	
i	In order not to endanger the operational safety of the clutch, unauthorized modifications and alterations are prohibited!



2.5. Personal protective equipment

To minimize health risks during work, it is necessary to wear personal protective equipment.

- The protective equipment corresponding to the work being carried out must be worn at all times.
- Pay attention to all notices on personal protective equipment within the work area.

Only wear

The following must be worn for all work:

	<p>Close-fitting protective clothing with a low tear strength and no protruding parts. These clothes are principally designed to protect against being caught by moving machine parts.</p> <p>Do not wear rings, bracelets or other jewellery.</p>
	Goggles to protect the eyes from flying parts and liquids

2.6. Specific dangers

The following section specifies residual hazards identified during risk assessment.

Pay attention to the safety instructions and warning notes specified in the following sections of these operating instructions in order to reduce the risk of damage to health and avoid dangerous situations.

Danger due to electric current

	⚠ DANGER
	<p>Danger due to electric current</p> <p>Contact with electrically live parts can lead to fatal injuries.</p> <ul style="list-style-type: none"> ▶ Do not touch electrically live parts. ▶ When working on/with the clutch, switch off the power and secure against switching on again ▶ Pay attention to the safety instructions

Danger due to magnetic fields

	⚠ DANGER
	<p>Danger to life of persons with heart pacemakers!</p> <p>The magnetic field of the electromagnetic tooth clutch can impair the function of heart pacemakers if the minimum distance for the pacemaker is not observed.</p> <ul style="list-style-type: none"> ▶ Persons with heart pacemakers may not work with the electromagnetic tooth clutch. ▶ Observe the regulations of BGV B11.

Moving components

	⚠ CAUTION
	<p>Risk of injury due to moving parts!</p> <p>Moving components can cause injuries.</p> <ul style="list-style-type: none"> ▶ Do not reach into moving parts with your hands or tamper with these parts during operation. ▶ Do not open the covers during operation. ▶ Wear close-fitting protective clothing in the danger zone.

2.7. Safety devices

The clutch is intended for use within a system.

It has no self-contained control system and no automatic emergency stop function.

Before putting the clutch into operation, install the EMERGENCY STOP device for the clutch and integrate this into the safety chain of the system control.

The EMERGENCY STOP device must be connected in such a way that interruption or re-activation of the power supply following such an interruption does not represent a dangerous situation for persons or property.

The EMERGENCY STOP devices must be accessible at all times.



The operator must install safety devices that will shut down the machine/system as soon as a person enters the danger area of the device.

2.8. Signs

The following symbols and signs are located in the working area. These apply to the area immediate surrounding where they are attached.

	⚠WARNING
	<p>Risk of injury due to illegible symbols!</p> <p>Due to dirt or other causes, stickers and signs can become illegible.</p> <ul style="list-style-type: none"> ▶ All safety, warning and operating instructions must remain legible. ▶ Damaged signs or stickers must be replaced immediately.

	⚠DANGER
	<p>Danger to life of persons with heart pacemakers!</p> <ul style="list-style-type: none"> ▶ Persons with heart pacemakers may not work in the designated area.

	<p>Electrical power</p> <ul style="list-style-type: none"> ▶ Only qualified electricians may work in the designated work area. ▶ Unauthorized persons may not enter the designated area or open the designated cabinets.
	<p>Strong magnetic fields</p> <ul style="list-style-type: none"> ▶ Strong magnetic fields occur in the designated work area.

3. Technical Specifications

Size	12	13	15	21	23	25	31	32
Nominal torque [Nm]	20	25	50	100	250	500	1000	2200
Coil voltage U [V] ± 10%	24*	24*	24*	24*	24*	24*	24*	24*
max. rotating speed [rpm] Dry run	1500	1500	1500	1500	1500	1500	1500	1500
max. rotating speed [rpm] Oil run	3000	3000	3000	2500	2500	2500	2300	2000
Idle speed air gap 1 ± 0.1	0.2	0.3	0.3	0.4	0.4	0.4	0.5	0.5
Bore diameter d10 [mm] for clamp pins	-	4.5	4.5	5.5	7.8	9.5	9.5	11.5
Run-out [F]	0.05	0.06	0.06	0.07	0.07	0.07	0.08	0.08

*The coil voltage is 24 V DC by default. On request, the coil can be designed for the following voltages: 12, 48, 96, 110, 196, 230 V DC

NOTE	
i	<p>For additional technical data, refer to the sectional drawing in section 4 "Setup and method of function" as well as the assembly drawing.</p> <p>The assembly drawing can be requested from the manufacturer.</p>

3.1. Connection dimensions, connection fixings

Refer to the assembly drawing for connection dimensions and information on connection fixings.

NOTE	
i	<p>The assembly drawing can be requested from the manufacturer.</p>

4. Setup and method of function

4.1. Setup

4.1.1. Individual parts view

Bf. 3 = Stator
Design 3

Bf. 4 = Stator
Design 4

2 Stator housing

3 Switching ring

4 Coil

5 Rotor design 3

6 Armature ring
(variable design)

S = Face

G = Thread pull-out

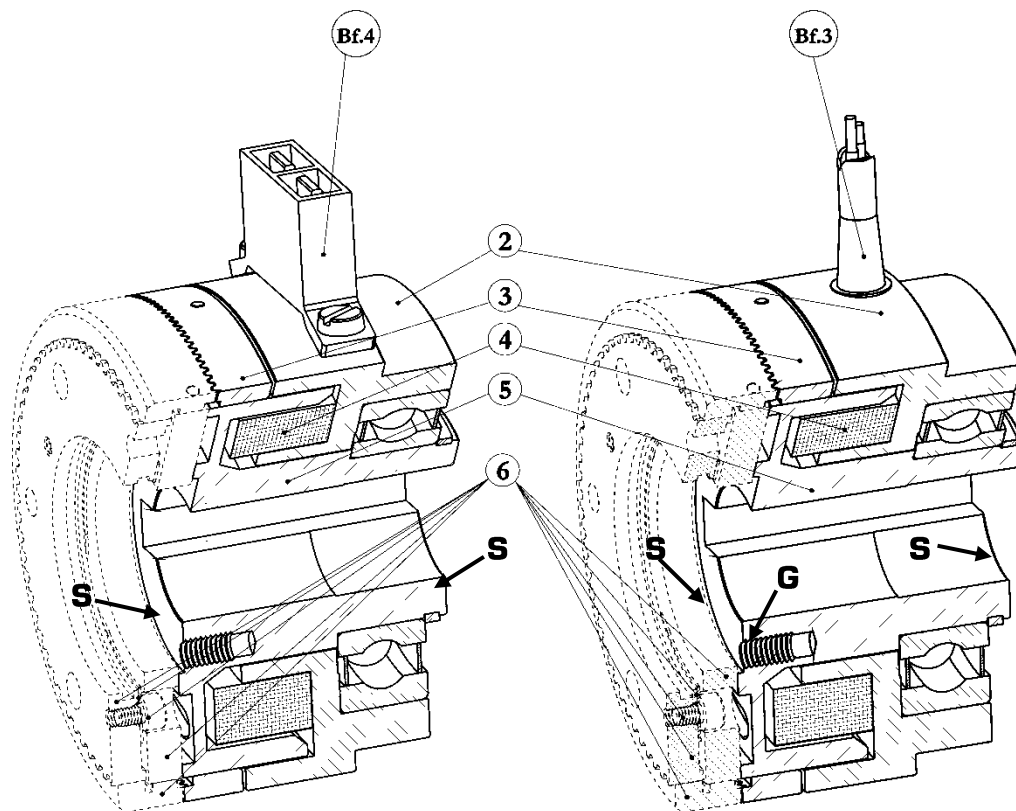
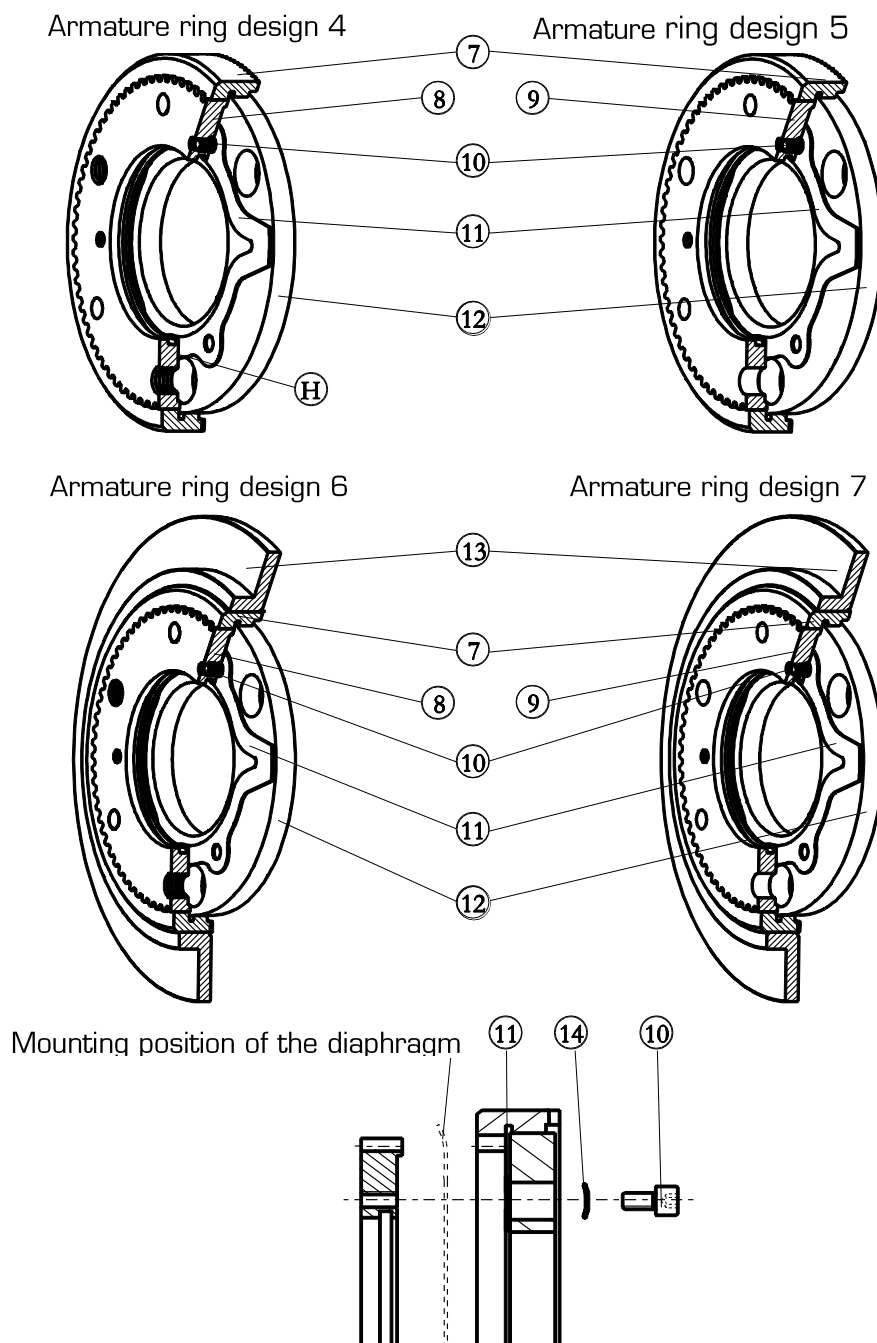

Figure 1: Sectional drawing and individual parts

4.1.2. Depiction of the different armature ring designs



- | | |
|----------------------------|-------------------|
| 7 Sprocket | 11 Diaphragm |
| 8 Centring part design 4 | 12 Armature ring |
| 9 Centring part design 5 | 13 Switching disk |
| 10 Diaphragm fixing screws | 14 Schnorr ring |

Figure 2: armature ring designs

4.2. Description

4.2.1. Features

Mönninghoff electromagnetic clutches are electromagnetically-operated spur-cut clutches with slip ring and mounted coil. They are distinguished by the following characteristics:

- High non-slip torque transmission.
- Small dimensions.
- Various gearing options.
- Possibility of synchronous switching.

4.3. Functional method

The electromagnet tooth clutch is operated electromagnetically. The tooth gear can be designed for various different applications.

By applying DC voltage U to the coil (4), a magnetic force is generated between the rotor (5) and the armature ring (12). This pulls the armature against the force of the diaphragm (11) in the direction of the stator housing. The tooth gear engages at relative movement.

If DC voltage is no longer applied, the magnetic field collapses and the restoring force of the diaphragm allows the tooth gear to disengage. The torque transmission is then interrupted and the armature is held in the idle position by the diaphragm.

5. Transport, packaging and storage

5.1. Safety instructions for transport

Improper transport

	ATTENTION
	<p>Damage due to improper transport!</p> <p>Improper transport can cause considerable damage.</p> <ul style="list-style-type: none">▶ When unloading the packaged items on delivery, as well as during in-house transport, proceed with care and pay attention to the symbols and instructions on the packaging.▶ Protect the clutch against heavy knocks as well as all types of force during transport.▶ Avoid strong ambient temperature fluctuations to prevent formation of condensation.▶ Remove the packaging immediately prior to installation.

	ATTENTION
	<p>Damage to property by magnetic fields!</p> <p>Electromagnetic clutches have a strong magnetic field that is for example, capable of destroying magnetically stored data.</p> <ul style="list-style-type: none">▶ Do not place electromagnetic clutches next to EC cards, video cassettes or other magnetic data storage devices or magnetically sensitive objects.

5.2. Transport inspection

The delivery should be checked immediately for completeness and for transport damage.

i	NOTE
	Failure to observe the following instructions will invalidate claims to the insurer for damage.

In the event of obvious visible transport damage, proceed as follows:

- Even if damage is only suspected, sign receipt of delivery (e.g. on the shipping document) with corresponding information under reservation.
- Determine and adhere to deadlines for submission of claims.
- Report the insurance claim immediately to the insurer and provide him with complete documentation of the damage as soon as possible (however, at the latest before possible exclusion and/or limitation periods for compensation claims against third parties expire) to enable acceleration of the claim processing procedure.

i	NOTE
	Register any claim as soon as a defect is detected. Claims for damage can only be accepted within the valid reclamation period.

5.3. Packaging

Regarding the packaging

The individual packages are packed according to the expected transport conditions. Environmentally compatible materials have been used exclusively for packing.

The size of the transport packaging depends on the quantity delivered.

Packaging should protect the components from transport damage, corrosion and other damage up until installation. For this reason, do not destroy the packaging and remove it only prior to installation.

Handling packing material

The packaging protects the clutch against damage during transit. The packaging materials were selected according to environmental and waste disposal aspects and can therefore be recycled.

Recycling the packaging material for further use saves raw materials and reduces waste. When no longer required, dispose the packaging materials according to local environmental regulations.

5.4. Removing from the packaging

Carefully remove the individual parts of the clutch from the packaging.

5.5. Storing the packaged items

Anticorrosion oil was applied to clutch parts not protected against corrosion, which must be stored in the original packaging.

Check the corrosion protection when the duration of storage exceeds six months. If the corrosion protection was removed during control of newly received goods, renew conservation (e.g., with Tectyl 472 from Valvoline).

Store packaged items under the following conditions:

- Do not leave outdoors.
- Store at a dry and dust-free location.
- Do not subject to aggressive media.
- Protect against solar radiation
- Avoid mechanical shocks and damage.
- Storage temperature: +5 to +45 °C.
- Relative humidity: max. 60 %.
- For storage longer than 3 months: regularly check the general condition of all components and packaging.

NOTE	
i	It is possible that instructions for storage are on the packaging that go beyond the stated requirements. Follow these instructions accordingly.

6. Installation

6.1. Safety

Staff

Installation and initial startup may only be carried out by specifically-trained specialist staff.

Danger due to electric current



	⚠ DANGER
	<p>Danger due to electric current!</p> <p>Contact with electrically live parts can lead to fatal injuries.</p> <ul style="list-style-type: none"> ▶ Do not touch electrically live parts. ▶ When working on/with the clutch, switch off the power and secure against switching on again ▶ Pay attention to the safety instructions

Danger due to magnetic fields

	⚠ DANGER
	<p>Danger to the life of persons with active health devices (heart pacemakers)!</p> <p>The magnetic field of the electromagnetic tooth clutch can impair the function of active health devices such as heart pacemakers if the minimum distance for respective device is not observed.</p> <ul style="list-style-type: none"> ▶ Persons with active health devices may not work with the electromagnetic tooth clutch. ▶ Observe the regulations of BGV B11.

Personal protective equipment

Wear the following protective equipment during all work on installation and initial startup:

	<p>Close-fitting protective clothing with a low tear strength and no protruding parts. These clothes are principally designed to protect against being caught by moving machine parts.</p> <p>Do not wear rings, bracelets or other jewellery.</p>
	<p>Goggles to protect the eyes from flying parts and liquids</p>

Improper installation and initial startup

	⚠CAUTION
	<p>Risk of injury due to improper installation and initial startup!</p> <p>Improper installation and initial startup can lead to personal injury or material damage.</p> <ul style="list-style-type: none"> ▶ Before beginning work, ensure that sufficient workspace is available for assembly. ▶ Be careful when handling exposed, sharp-edged components. ▶ Pay attention to tidiness and cleanliness at the workplace! Components and tools lying around or on top of each other can be sources of accidents. ▶ Assembly components must be properly installed. Adhere to the specified screw torques.

6.2. Preparation

Before installing, check the following points:

- The clutch should not show any deformation, scratches and other damage indicating that it was dropped.
- A sufficient electric supply must be assured (see section "**Technical Data**").

6.3. Assembly

Rotor assembly design 3 with stator design 3 or design 4

	NOTE
	<p>The electromagnetic tooth clutch is delivered in an installable condition. It is not necessary to assemble the individual components.</p>

Check the parts for completeness, dimensional stability and damage. Clean the shaft ends and flange holes thoroughly.

i	NOTE
	The shaft fitting should be h7 to j6 The rotor borehole for the shaft is H7 by default.

	ATTENTION
	<p>Damage due to improper, forced assembly!</p> <p>Improper, forceful assembly can cause considerable damage to property.</p> <ul style="list-style-type: none"> ▶ Never forcefully strike or press the rotor onto the shaft! ▶ Only apply assembly force to the front face of the rotor! ▶ No power may be directed into the stator!

- Push the stator and the rotor onto the drive shaft of the machine.
- Only apply assembly force to the faces of the rotor marked with "**S**" in order not to damage the rotor and the switching ring.
- Secure the rotor against axial shifting.
- Secure the stator housing against twisting by putting a safety guard (arrow) into the groove provided.

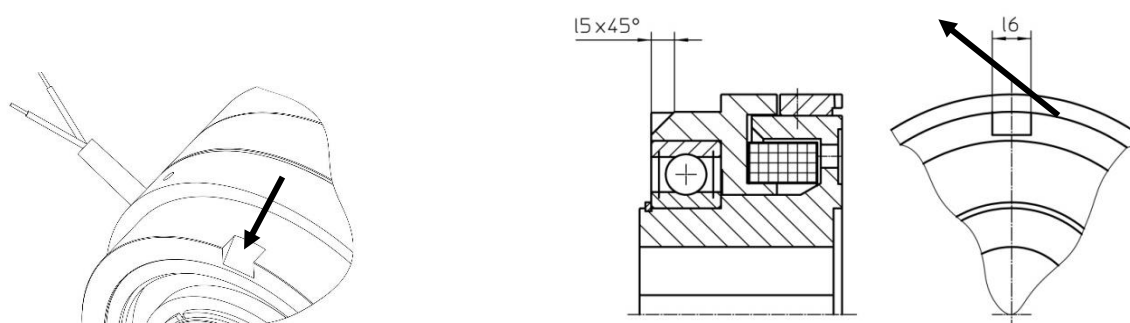

Figure 3: Twist protection

Twist protection dimensions		
Clutch size	Dimension "I 5"	Dimension "I 6"
12	4,5 mm	5 mm
13	5 mm	6 mm
15	6 mm	8 mm
21 and 23	6 mm	10 mm
25	8 mm	10 mm
31 and 32	10 mm	12 mm

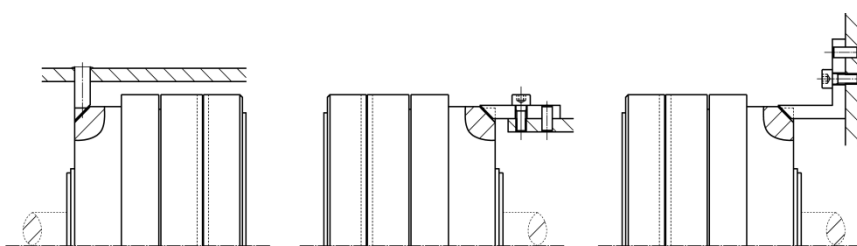



Figure 4: Twist protection version examples

i	NOTE
	The twist protection is not supplied and must be adjusted to the relevant installation conditions by the user.

Connection of the stator to the power supply by means of litz wires (design 3) or plug-in connector (design 4) may only take place after the clutch has been completely assembled. For dismantling the clutch, use pull-out thread "**G**" attached to the face of the rotor.

	ATTENTION
	<p>Damage due to improper, forced disassembly!</p> <p>Improper, forceful dismantling can cause considerable damage to property.</p> <ul style="list-style-type: none"> ▶ Never apply force to the switching ring or the external diameter of the rotor to avoid deformation of the rotor and resulting destruction of the clutch!

Assembling the armature for design 4 and 6

The only difference between armatures 4 and 6 is the switching ring installed in design 6. The centering part for design 4 and 6 gets fixed to a customer's connecting part with threaded holes. Assembly for both armature designs is identical.

- Dismantle the centering part (8). For this purpose, remove the three diaphragm fixing screws (10).
- The centering part for producing the pinholes can be taken from the armature.
- Bore the fixing pin holes to the required size.
- Subsequently clean the centering part thoroughly. Make sure that no drilling swarf remains in the tooth guide of the centering part.
- Grease the tooth guide with Molykote after cleaning and before reinstalling into the armature.
- Centre, screw and pin the centering part with its internal diameter to the component of the customer.

i	NOTE
	Make sure that the fixing pin and the ends of the threads do not protrude out of the front face " H " of the centering part (see fig. 4).

- Subsequently screw the centering part and armature.
- Push the assembled component onto the shaft.
- Put the rotor and armature together so that the run-out deviations between the rotor and armature are not greater than stated.
- Mount the centering part with the connecting machine part onto the clutch shaft and secure axially.
- The spacer sleeve (for setting the idle speed air gap) underneath the armature must be made of an antimagnetic material (see fig. 5).
- Subsequently set the idle speed gap of the clutch.

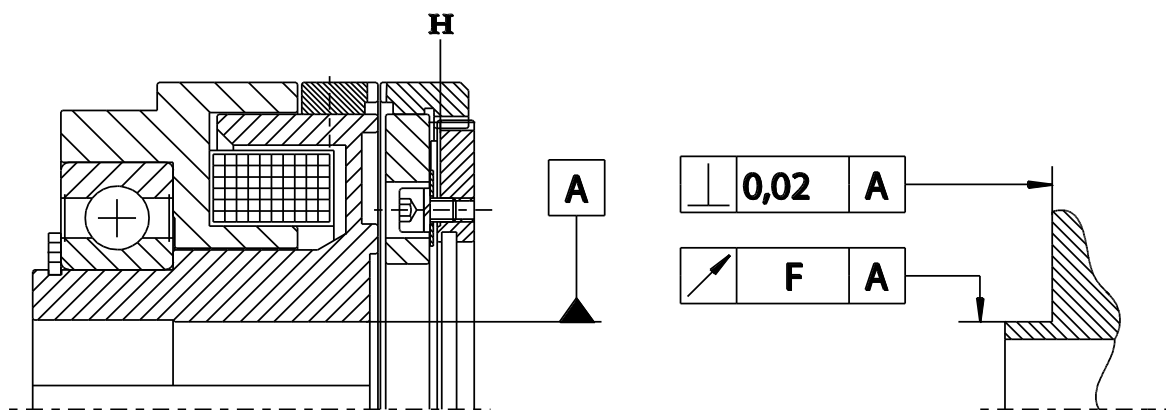

Figure 4: Face "H" of the centring part

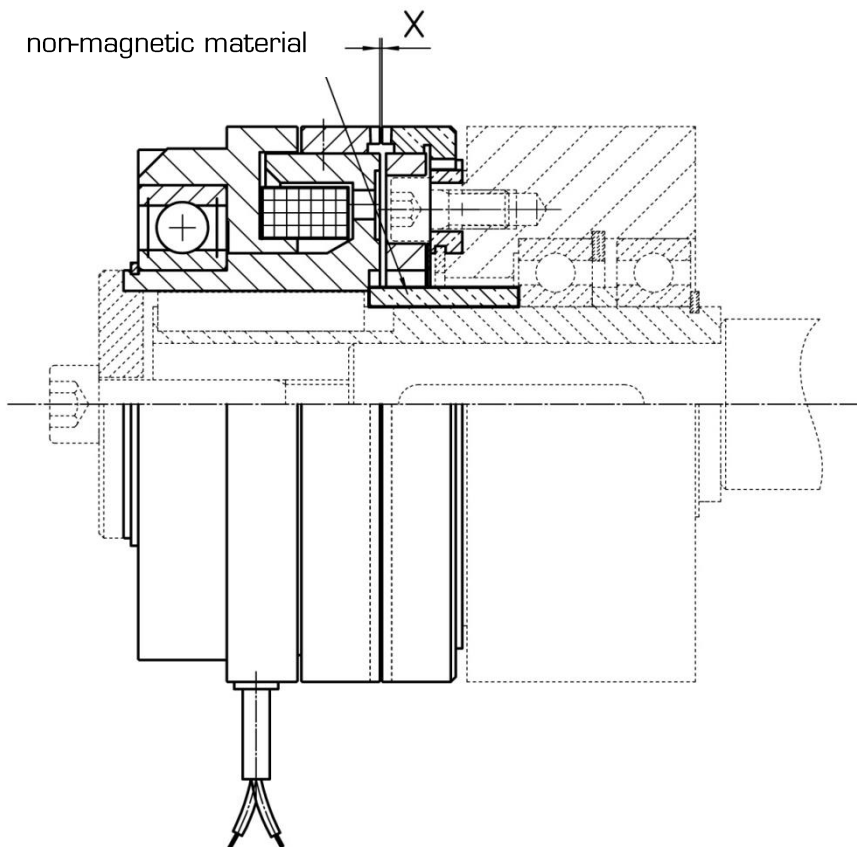

Figure 5: Spacer sleeve for setting the idle speed air gap

Assembling the armature
for design 5 and 7

The only difference between armatures 5 and 7 is the switching ring installed in design 7. The centering parts for design 5 and 7 gets fixed to a customer's connecting part with threaded holes. Assembly for both armature designs is identical.

- Dismantle the centering part (9). For this purpose, remove the three diaphragm fixing screws (10).
- The centering part for producing the pinholes can be taken from the armature.
- Bore the fixing pin holes to the required size.
- Subsequently clean the centering part thoroughly. Make sure that no drilling swarf remains in the tooth guide of the centering part.
- Grease the tooth guide with Molykote after cleaning and before reinstalling into the armature.
- Centre, screw and pin the centering part with its internal diameter to the component of the customer.

i	NOTE
	Make sure that the fixing pin and the ends of the threads do not protrude out of the front face " H " of the centering part (see fig. 4).

- Subsequently screw the centering part and armature.
- Push the assembled component onto the shaft.
- Put the rotor and armature together so that the run-out deviations between the rotor and armature are not greater than stated.
- Mount the centering part with the connecting machine part onto the clutch shaft and secure axially.
- The spacer sleeve underneath the armature must be made of an antimagnetic material.
- Subsequently set the idle speed gap of the clutch.

Setting the idle speed air gap

The idle speed air gap, meaning the gap between the tooth gears in a switched-off condition of the clutch, must be correctly set. If it is too big, the clutch will not engage properly. If on the other hand it is set too small, proper disengaging of the tooth gear is not possible.

Refer to the technical data for the idle speed air gap width dimension (see section 3).

i	NOTE
	After setting the idle speed air gap, do not shift the clutch components axially!

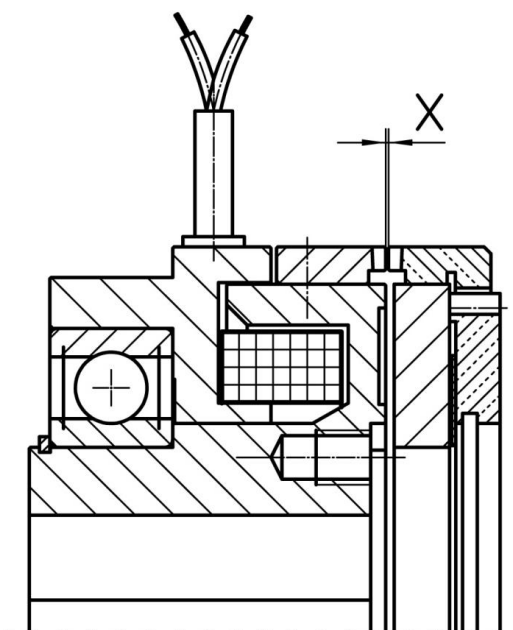





Figure 6: Idle speed air gap "X"

Electrical connection

	⚠ DANGER
	<p>Danger due to electric current</p> <p>In the case of electromagnetically-operated device, it is possible that dangerously high electrical voltages are induced during the switch-off procedure.</p> <ul style="list-style-type: none"> ▶ To prevent high induction voltage peaks, install voltage-dependent resistors (varistors) parallel to the coil or provide a protective circuit. ▶ Do not touch electrically live parts. ▶ Observe the current safety regulations at the place of use for the installation of electrical systems.

	⚠ DANGER
	<p>Danger to life of persons with heart pacemakers!</p> <p>The magnetic field of the electromagnetic tooth clutch can impair the function of heart pacemakers if the minimum distance for the pacemaker is not observed.</p> <ul style="list-style-type: none"> ▶ Persons with heart pacemakers may not work with the electromagnetic tooth clutch. ▶ Observe the regulations of BGV B11.

	NOTE
	<p>Only operate the electromagnetic tooth clutch with direct current.</p>

The design of a coil corresponds to the coil voltages specified in the technical data (see section 3).

Polarity is freely selectable.

The coil is designed for a holding voltage of 24 V DC at a switching time of 100% ED.

Switch the current only in the DC current circuit to prevent switch-on and switch-off delays when switching the clutch.

7. Startup

Danger due to electric current

	⚠ DANGER
	<p>Danger due to electric current!</p> <p>Contact with live components can be fatal. Switched-on electrical components can cause uncontrolled movement and lead to serious injuries.</p> <ul style="list-style-type: none"> ▶ Before beginning any work, switch off the power and secure against switching on again.

Danger due to magnetic fields

	⚠ DANGER
	<p>Danger to the life of persons with active health devices (heart pacemakers)!</p> <p>The magnetic field of the electromagnetic tooth clutch can impair the function of active health devices such as heart pacemakers if the minimum distance for respective device is not observed.</p> <ul style="list-style-type: none"> ▶ Persons with active health devices may not work with the electromagnetic tooth clutch. ▶ Observe the regulations of BGV B11.

Danger due to rotating components

	⚠ CAUTION
	<p>Damage to persons due to moving components!</p> <p>Rotating components can cause injury.</p> <ul style="list-style-type: none"> ▶ Never reach into the area of the rotating clutch and shafts! ▶ Protect the clutch against unintentional access during operation!

- Check for correct assembly of all components before startup of the clutch.
- Check tooth gear for proper engaging and disengaging.
- Check the function of all safety devices that are used with the clutch.

- Switch on the clutch.
- Start up the system.
- The clutch must be engaged or engage during startup.

i	NOTE
	Letting the clutch slip through is not permitted!

- Watch the clutch.
- The clutch can be put into continuous operation after checking for proper function.

	ATTENTION
	<p>Danger of damage to the clutch when switching at too high differential speeds.</p> <p>Switching the clutch at too high differential speeds causes wear or destruction of the tooth gear.</p> <ul style="list-style-type: none"> ▶ Switch on clutches with fixed-point switching only at very low differential speeds

i	NOTE
	It is not possible to specify the maximum possible switching speed.

8. Operation

8.1. General

The clutch is operated fully automatically after startup. Manual intervention is only required for cleaning and fault rectification.

8.2. Recommendations for operation

Pay attention to all relevant safety and accident prevention regulations for the place of operation during operation.

The operating staff must be familiar with the details of operating the clutch before startup.

Danger due to electric current

	⚠DANGER
	<p>Danger due to electric current!</p> <p>Contact with live components can be fatal. Switched-on electrical components can cause uncontrolled movement and lead to serious injuries.</p> <ul style="list-style-type: none"> ▶ Before beginning any work, switch off the power and secure against switching on again.

Danger due to magnetic fields

	⚠DANGER
	<p>Danger to the life of persons with active health devices (heart pacemakers)!</p> <p>The magnetic field of the electromagnetic tooth clutch can impair the function of active health devices such as heart pacemakers if the minimum distance for respective device is not observed.</p> <ul style="list-style-type: none"> ▶ Persons with active health devices may not work with the electromagnetic tooth clutch. ▶ Observe the regulations of BGV B11.

	⚠CAUTION
	<p>Damage to persons due to rotating components!</p> <p>Rotating components can cause injury.</p> <ul style="list-style-type: none"> ▶ Never reach into the area of the rotating clutch!

	NOTE
	<p>Only operate the clutch according to the protective requirements in DIN VDE 0580.</p>

- Cover the clutch to protect it against dirt and magnetic dust.
- Observe the required radio interference suppression measures.

- Take adequate measures according to DIN VDE 0848 part 4 to rule out danger to persons and property by direct or indirect electromagnetic fields.

In an unassembled condition, the clutch has IP00 degree of protection according to DIN VDE 0470. The choice of location for setup and use must consider these circumstances. When applicable, take protective measures to increase the degree of protection if the ambient conditions make this necessary.

i	NOTE
	<p>If safety-relevant changes occur during operation of the clutch, stop the system immediately and repair or replace the clutch.</p> <p>If in doubt, contact the manufacturer.</p>

In the case of electromagnetic tooth clutches that are designed for "oil running" (clutch is not immersed; only splash oil), use only synthetic oil or mineral oil without zinc additives or mixtures containing zinc (e.g., zinc dialkyl dithiophosphates / service life additives).

Only use oils with a viscosity up to $25 \times 10^{-6} \text{ m}^2/\text{s}$ at 50°C ($3^\circ\text{E}/50^\circ\text{C}$).

9. Faults

Possible causes of faults and their elimination are described in the following section.

If a fault cannot be eliminated after following the instructions provided, the manufacturer should be contacted, see service addresses on page 9.

9.1. Safety

Danger due to electric current

	⚠ DANGER
	<p>Danger due to electric current!</p> <p>Contact with live components can be fatal. Switched-on electrical components can cause uncontrolled movement and lead to serious injuries.</p> <p>► Before beginning any work, switch off the power and secure against switching on again.</p>

Danger due to magnetic fields

	⚠ DANGER
	<p>Danger to the life of persons with active health devices (heart pacemakers)!</p> <p>The magnetic field of the electromagnetic tooth clutch can impair the function of active health devices such as heart pacemakers if the minimum distance for respective device is not observed.</p> <ul style="list-style-type: none"> ▶ Persons with active health devices may not work with the electromagnetic tooth clutch. ▶ Observe the regulations of BGV B11.

Staff



- Faults may only be eliminated by specially trained, qualified staff.
- Work on electrical systems may only be carried out by specialist qualified electricians.

Danger due to rotating components

	⚠ CAUTION
	<p>Damage to persons due to rotating components!</p> <p>Rotating components can cause injury.</p> <ul style="list-style-type: none"> ▶ Never reach into the area of the rotating clutch!

Personal protective equipment

Wear the following protective equipment during work with the clutch:

	<p>Close-fitting protective clothing with a low tear strength and no protruding parts. These clothes are principally designed to protect against being caught by moving machine parts.</p> <p>Do not wear rings, bracelets or other jewellery.</p>
	<p>Goggles to protect the eyes from flying parts and liquids</p>

Improperly performed work on elimination of faults

⚠WARNING	
	<p>Risk of injury from improperly performed work on elimination of faults!</p> <p>Improperly performed work can cause severe damage to persons and property.</p> <ul style="list-style-type: none"> ▶ Before beginning work, ensure that sufficient workspace is available for assembly. ▶ The following applies to the system, in which clutch is operating: never disable the safety devices in the system. ▶ Pay attention to tidiness and cleanliness at the workplace! Components and tools lying around or on top of each other can be sources of accidents. ▶ If components are removed, pay attention to correct assembly; replace all fixing elements and adhere to all screw torques. ▶ In the event of malfunctions or irregularities, stop the system and clutch and inform the person responsible. If faults cannot be rectified, contact the service department of the Maschinenfabrik Mönninghoff GmbH & Co. KG. ▶ In the event of errors, switch off all electrical connections before determining the fault.

9.2. Malfunctions

The following table provides an overview of possible faults and their causes. If there any uncertainties or questions, consult the manufacturer.

Error	Possible cause	Remedy
Clutch switches off after delay	Tooth guide of the centering part heavily contaminated or damaged	Dismantle the clutch, check tooth guide, clean and grease with Rocol MTS 2000 If damaged, return the clutch for repair

Error	Possible cause	Remedy
Clutch does not switch	Electrical supply interrupted Voltage supply defective	Check voltage supply and supply lines
	Coil has short circuit or ground fault	Measure the resistance of the coil. Compare the measured resistance with the nominal resistance (see technical data for value). If the resistance is too low, replace the clutch and return for repair
	Wiring is wrong or defective	Check wiring check cable for continuity
	Idle speed air gap set too big	Check and correct idle speed air gap
Clutch does not engage or only after considerable delay	Differential speed too high Fixed-point tooth cannot engage fast enough	Lower speed, preferably switch clutch at standstill
Clutch does not switch off	Idle speed air gap set to small, tooth gear cannot disengage	Check idle speed air gap and reset
	Diaphragm is damaged or permanently deformed	Dismantle the clutch and return for repair
	Armature assembly not properly installed	Install armature assembly properly
Clutch engages but it subsequently slips due to	Overloading	Stop the system immediately and eliminate the cause of overloading
	Tooth gear worn or destroyed	Dismantle clutch and replace
	Magnetic field not strong enough Coil probably defective	Check coil and if defective, replace clutch
	Idle speed air gap too big	Set idle speed air gap
Clutch does not engage or only after considerable delay	Differential speed too high Fixed-point tooth cannot engage fast enough	Lower speed, preferably switch clutch at standstill

10. Maintenance

The clutch does not require regular maintenance work.

Work on the clutch is only necessary when rectifying a fault. When rectifying a fault, pay attention to the safety instructions in section 9 "**Malfunctions**".

10.1. Wear checking

	⚠CAUTION
	<p>Damage to persons due to rotating components!</p> <p>Rotating components can cause injury.</p> <ul style="list-style-type: none"> ▶ Only check for wear when the machine is at a standstill! ▶ Never reach into the area of the moving clutch!

	NOTE
	<p>The electromagnetic tooth clutch is maintenance free. Nevertheless, the tooth gear must be checked regularly for wear.</p>

The intervals for wear checking depend on the conditions at the place of operation. Increased load of the electromagnetic tooth clutch due to increased switching frequency or frequent overload conditions necessitates shorter intervals.

The intervals for checking are determined by information obtained during operation.

	NOTE
	<p>Store reserve clutches to keep system downtime as short as possible in the event of a disturbance.</p>

When the end of the service life is reached, the clutch must be dismantled and disposed according to environment regulations.

10.2. Safety

Staff

- Dismantling may only be performed by qualified staff.

Electrical system

	⚠ DANGER
	<p>Danger from electric current!</p> <p>Contact with live components can be fatal.</p> <ul style="list-style-type: none">▶ Before beginning any work, switch off the power and secure against switching on again.

10.3. Dismantling

Electrical system

Before dismantling:

- Switch off the system, in which the clutch is installed and secure against being switched on again.
- Physically disconnect the entire power supply.

Subsequently clean modules and components properly and dismantle in accordance with local occupational safety and environmental protection regulations.

10.4. Disposal

If no agreement was made on product return and disposal, please submit dismantled components for recycling:

- Scrap metals
- Submit plastic elements for recycling.
- Sort and dispose of other components according to material characteristics.

ATTENTION	
	<p>Environmental damage due to improper disposal!</p> <ul style="list-style-type: none"> ▶ Electrical scrap, electronic components, lubricants and other accessories are subject to special waste handling and must be disposed by authorized specialist companies only! ▶ The local authorities or special waste disposal companies can provide information on proper disposal according to environmental regulations.

11. Applicable standards, guidelines and regulations

Standard	Designation
DIN 740 - 1	Drive technology; flexible shaft couplings; Requirements; technical delivery conditions
DIN 740 - 2	Drive technology; flexible shaft couplings; Terms and calculation bases
DIN VDE 0470	Protection class by housing (IP code)
DIN VDE 0580	Electromagnetic devices
DIN 31000	General principles for safety-conscious design of technical products
DIN 867	Reference profile for involute gears
DIN ISO 281	Dynamic load ratings and nominal life cycle calculation procedure for rolling bearings
DIN ISO 1940	Requirements on the balancing quality of rigid rotors
VDI 2230 sheet 1	Systematic calculation of heavily loaded screw connections; Cylindrical screw-in connections
VDI 2230 sheet 1	General principles for safety-conscious design of technical products; Safety technology terms; basic terms