



Series 16 Gas Springs

Lift, support, damping and adjustment devices

Gas Springs: Series 16

For nearly 50 years, SUSPA has offered a proven, time-tested, high-performance gas spring line: SERIES 16. Conforming to the highest worldwide standards for lifting and counter-balancing, it features simple, easy motion. The basic design allows for a wide variety of applications with different forces, and takes into consideration ecological conservation.

SUSPA - Your partner from design through production

- SUSPA support from concept through production leads to optimum gas spring performance for your application.
- SUSPA service is quick and reliable, regardless of the volume of your order.
- SUSPA gas springs can be adapted to many environmental conditions.
- SUSPA Hyrdo-Strut gas springs block on compression, allowing infinite positioning of the piston rod. They can be designed for your specific application.
- SUSPA also offers non-pressurized dampers, designed for your specific application.
- SUSPA products meet global standards.

A few words about quality

The demand for quality and reliability in adjustment components is constantly increasing. Compliance with certifications such as ISO 9001 and ISO TS 16949 is imperative. SUSPA continues to be on the leading edge with the highest product standards.

All cylinders in this brochure are covered by a 5-year limited warranty. (Warranty to the original purchaser of the cylinder, not the end user.)

SUSPA has achieved worldwide recognition for quality and ecological effectiveness. This involves design, engineering, production and distribution. We devote attention to details such as delivery, shipping logistics, product performance and durability.

SUSPA components meet rigid quality standards prior to assembly, while random sampling is performed on all production lots.

All products in this brochure are RoHS compliant.



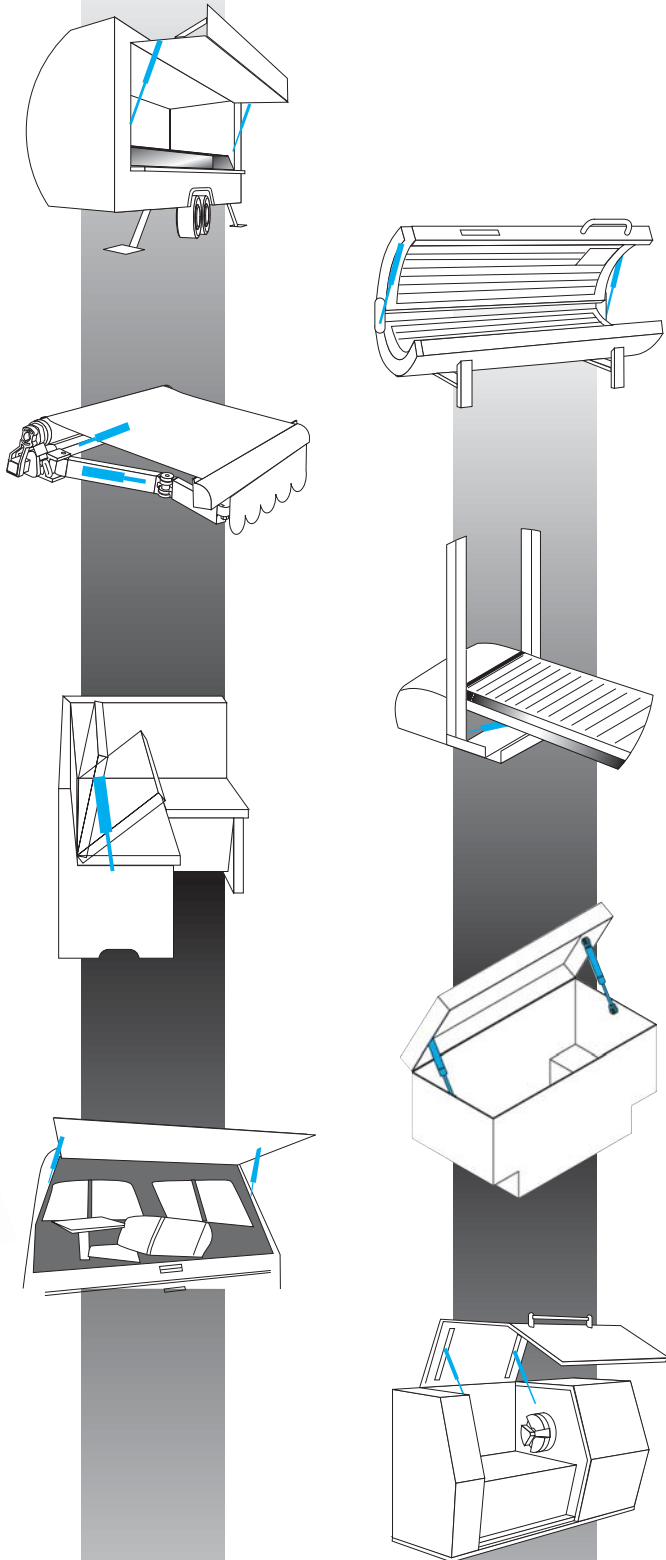

A Variety of Applications

With thousands of applications already in existence, the potential new uses for SUSPA gas springs are virtually limitless.

SUSPA gas springs offer a unique alternative to conventional mechanical coil springs used in lifting or counterbalancing devices.

Some residential uses include skylights, lawn and garden equipment, exercise equipment, awnings and fold-up benches.

In health care, hospital beds, operating room tables and even tanning beds are equipped with gas springs.

In office settings, gas springs and dampers have proven to be acceptable and useful. Some applications include overhead office bins, copy machines, blueprint plotters, mail processing equipment and counterbalance arms for computer terminals.

Automotive uses include tailgates, engine hoods, tonneau covers, pick-up cap windows and luggage doors on busses.

SUSPA gas springs and dampers are used on the shop floor in applications such as machine guards, conveyor gates and flex-arms.

All custom gas springs can be made with non petroleum based oil.

Definitions & Operations

A gas spring is a self-contained, hermetically-sealed hydropneumatic linear actuator containing pressurized nitrogen gas, which provides an output force.

SUSPA gas springs offer a unique alternative to conventional mechanical or coil spring lifting or counterbalancing devices. The advantages of these springs involve a combination of a relatively flat force curve, controlled forces and extension speed, and damping at the end of the stroke. The spring rate for a gas cylinder, as the illustration (below) shows, is far less than for any mechanical spring.

Each gas spring also contains a specific amount of oil, which lubricates the seal, piston and piston rod. The oil and gas within the cylinder moves from one side of the piston head to the other when compressed or extended, providing a damping effect. This flow can be controlled either on extension, compression, or both.

In its "unloaded" static state, the piston rod within the cylinder extends outside of the gas-pressurized tube. The extended output force (P1) is a result of the difference between the internal gas pressure and the outside atmospheric pressure. As the piston rod is compressed, the internal pressure and output force increase according to the rod volume displaced. During rod extension, the internal pressure and output force decrease according to the reduced internal rod volume.

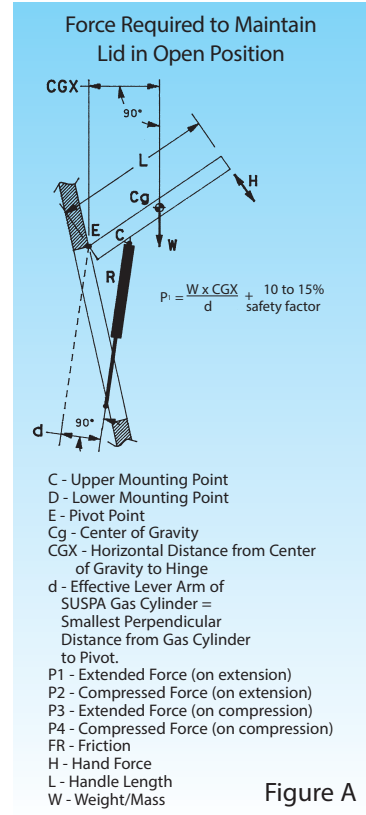
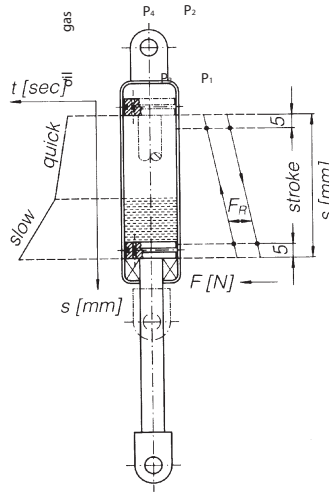
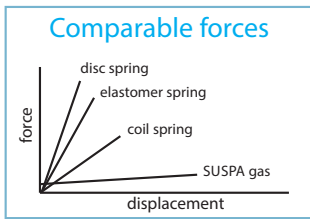

Figure A



Tube/rod combinations

Choose your end fittings for the most flexibility Ball sockets allow for misalignment far better than clevises and eyelets. Any misalignment with clevis-type end fittings may cause binding, which may adversely affect the system's operation characteristics and the cylinders' durability. If clevis end fittings are required, choose pivot pins which are smaller than the hole diameter specified for the model. When choosing end fittings which are threaded onto the cylinder, check that the end fitting threads match with the threads on the cylinder. Information on this is contained in the table on each SERIES 16 product description, beginning on page 7.

Determine the extended length of the cylinder The fully-extended length of the cylinder can be calculated by adding the tube length, rod stroke and both end fitting lengths. The solid length of the cylinder can be established by adding the tube length and both end fitting lengths. It is not recommended that you design the cylinder to the solid (compressed) length of the cylinder. 10mm of unused stroke (in the compressed position) generally is designed into the system to allow for mounting location tolerances and overtravel.

Choose a tube longer than the rod

Our published directions specify using a 27mm additional tube length for a Model 16-1 cylinder; 37mm additional tube length for a 16-2, 16-3 and 16-4 cylinder. This minimum value, which can be exceeded, makes cylinders such as a Model 16-4-262-200-(end fittings)-(P1 force) possible. A 16-4-180-175-(end fittings)-(P1 force)cylinder is not recommended.

Mounting locations

The most common cylinder applications are represented in figures A, B and C. These locations most often offer the best lid opening characteristics. As sketched, the mounting points are dimensioned from the pivot when the lid is in the closed position. When information is to be sent to the Suspa design engineers, using this format will enhance turnaround time and require less clarification.

In the illustrations, the dimensions identified as **FX** and **FY** are referred to as the fixed mounting points, and the dimensions marked **MX** and **MY** are referred to as the moving mounting points. The location of the center of gravity is represented by the dimensions **CGX** and **CGY**. The accuracy of locating the center of gravity and weight is crucial for complete design analysis. Again, all dimensions should be given for the lid in the closed position.

Note: It is recommended that the gas spring usually be mounted with the rod end down.

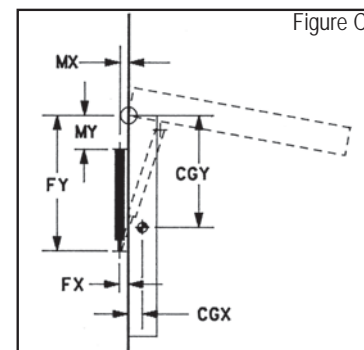
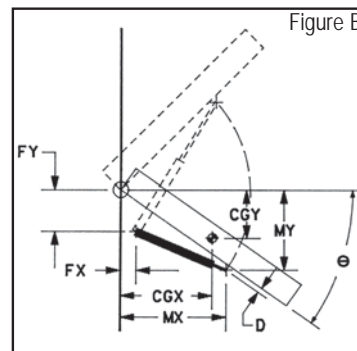
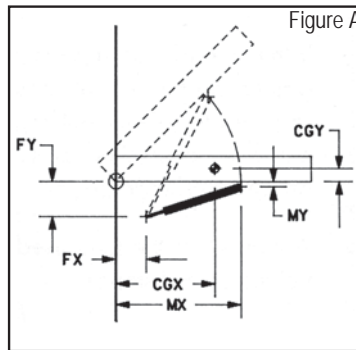

Determining forces

The required output force can be determined as is shown in figure A on page 4. Proportionately, the piston rod diameter, relative to the tube diameter, influences the extended-to-compressed force ratio (P1 to P2 or P3 to P4). Lower ratios require a small piston rod and large tube diameter combination, such as Model 16-3.

In applications using extremely long strokes, coupled with high forces, strong consideration should be given to larger piston rod diameters, as they offer greater strength. Side-loading always should be avoided.

Durability

SUSPA SERIES 16 gas springs undergo a standard test for durability. The test consists of 15,000 cycles ambient, plus 1,000 cycles at the temperature extremes of -30°C and +80°C (-22°F and 176°F) at a maximum rate of six cycles per minute, with an acceptable maximum pressure loss of 10% or less. SERIES 16 gas springs are not rated for a specified number of cycles. They are designed for the characteristics of nitrogen gas, and are tested for pressure loss.

Temperature

SUSPA SERIES 16 gas springs are rated for use at temperature extremes of -30°C and +80°C (-22°F and 176°F) and are temperature compensated to 20°C (68°F) during assembly. Output force will temporarily increase or decrease by 3.4% for every 10°C change in temperature from 20°C.

***Call engineering for design assistance**

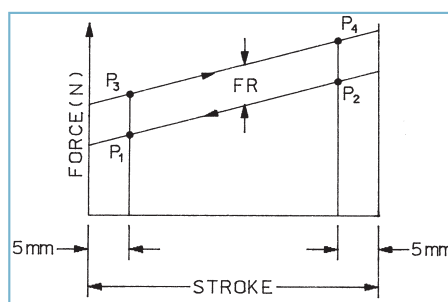

The illustration (left) is an example of a plotted force curve. This demonstrates the location of P₁ and P₂ forces on a force diagram. Note, also, that 10mm of overtravel is normally allowed in the compressed position. This is a minimum value for overtravel safety, and may be exceeded.

Application Information

Note: Copy this page and fill in the information to assure expedient handling of your application at SUSPA.



SUSPA, Incorporated
 3970 Roger Chaffee Dr. SE
 Grand Rapids, MI 49548-3497
 616-241-4200
 FAX 616-531-3310
 E-mail: sim@us.suspa.com
 www.suspa.com

Date _____ E-Mail _____

Name _____

Company _____

Address _____

City _____ State _____ Zip _____

Phone _____ Fax _____

Application Description _____

Expected Annual Usage: _____

Our Application would be best described by type: A B C

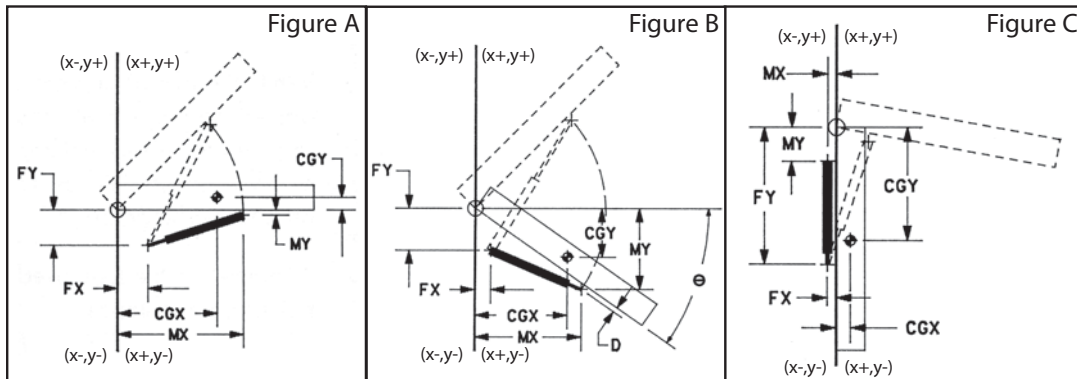

To expedite this design, please provide all possible dimensions (in millimeters)

Performance Characteristics

- Opening angle _____°
- Self Rising
- Self Rising after _____° lift. (15-30° standard)

Is the cover latched or locked? (Y / N)

Preferred Mounting Method:

- Ball Socket _____
- Clevis Eye _____

Currently using gas cylinders? (Y / N)

Manufacturer _____

Part Number _____

Performance Characteristics

Weight of lid/door _____ (Lbs/Kg)

Number of cylinders per lid/door _____

All dimensions are from Pivot Center Line

With lid in closed position. Circle correct sign of dimension.

$F_x \pm$ _____ $F_y \pm$ _____ $M_x \pm$ _____ $M_y \pm$ _____ $CG_x \pm$ _____ $CG_y \pm$ _____

Distance from hinge to handle _____

-----Type B Application only-----

θ = Angle from horizontal _____

D = Distance from mounting surface _____

T = Thickness of lid or door _____

Please include a cross sectional sketch noting any mounting restrictions.

SUSPA application simulation reports are provided for reference only.

Correct incorporation and use of SUSPA provided gas cylinders or dampers is the sole responsibility of the user. Lack of proper information may delay processing of design.

Series 16 Standard Gas Springs

SUSPA offers a variety of Standard 16 SERIES gas lift cylinders to meet the increasing needs of customers who want fast shipments of SUSPA gas springs at economical prices. Nine combinations currently are available, incorporating the most popular lengths and output forces.

All Standard 16 SERIES gas lift cylinders carry the SUSPA five year warranty from date of manufacture. Any deviations from the models listed here can be produced on request-- thousands of different configurations are possible.

The proper selection of SUSPA gas springs, and the incorporation of them into specific products, remain the sole responsibility of the buyer. SUSPA reserves the right to make changes without advance notice.

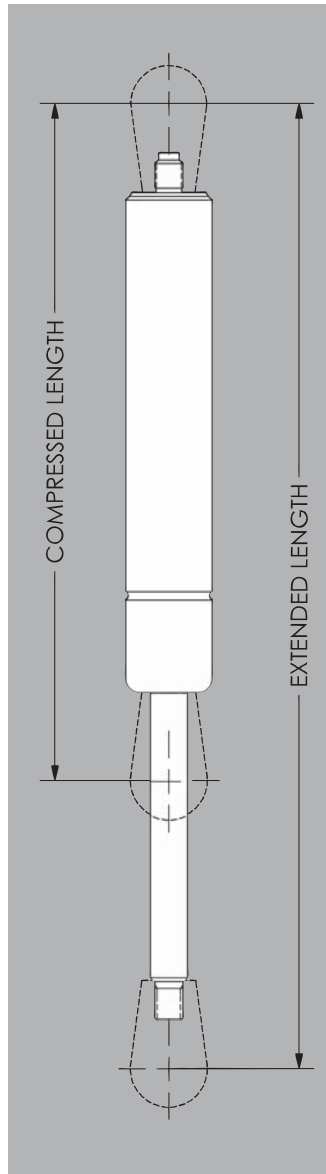

SGS No.	Model No.	Part No.	P1 Force	
			(N)	(lbs)
1	16-2-132-080-A101-B101 Center-to-Center length Extended: 9.8" (250mm) Compressed: 6.7" (170mm)	C16-03213	60	13.5
		C16-10334	98	22
		C16-09322	178	40
		C16-10445	222	50
		C16-12103	334	75
2	16-2-172-100-A101-B101 Center-to-Center length Extended: 12.2" (310mm) Compressed: 8.3" (210mm)	C16-02716	60	13.5
		C16-03795	107	24
		C16-10788	156	35
		C16-12104	222	50
		C16-12105	289	65
3	16-2-237-160-A101-B101 Center-to-Center length Extended: 17.1" (435mm) Compressed: 10.8" (275mm)	C16-02622	134	30
		C16-02648	166	37
		C16-06874	178	40
		C16-04270	211	47
		C16-04445	255	57
4	16-2-263-200-A101-B101 Center-to-Center length Extended: 19.7" (501mm) Compressed: 11.9" (301mm)	C16-06867	267	60
		C16-08777	289	65
		C16-08789	356	80
		C16-06889	432	97
		C16-06756	470	106
5	16-4-262-200-A011-B011 Center-to-Center length Extended: 20.6" (522mm) Compressed: 12.7" (322mm)	C16-11253	600	135
		C16-08568	89	20
		C16-09786	133	30
		C16-08316	178	40
		C16-08260	267	60
6	16-4-262-200-A016-B016 Center-to-Center length Extended: 19.4" (494mm) Compressed: 11.6" (294mm)	C16-08053	356	80
		C16-08054	445	100
		C16-08055	534	120
		C16-08376	600	135
		C16-08111	290	65
7	16-4-371-260-A198-B198 Center-to-Center length Extended: 26.34" (669mm) Compressed: 16.10" (409mm)	C16-03472	385	87
		C16-05470	435	98
		C16-03473	510	115
		C16-03474	595	134
		C16-04650	712	160
8	16-4-452-410-A198-B198 Center-to-Center length Extended: 35.43" (900mm) Compressed: 19.29" (490mm)	C16-06340	830	187
		C16-03475	1000	225
		C16-00816	222	50
		C16-00087	290	65
		C16-00088	385	87
9	16-4-452-410-A011-B011 Center-to-Center length Extended: 36.3" (922mm) Compressed: 20.2" (512mm)	C16-00086	435	98
		C16-00010	510	115
		C16-00011	595	134
		C16-00001	712	160
		C16-00009	830	187
9	16-4-452-410-A011-B011 Center-to-Center length Extended: 36.3" (922mm) Compressed: 20.2" (512mm)	C16-00357	1000	225
		C16-13334	385	87
		C16-12666	445	100
		C16-12038	534	120
		C16-12181	667	150
9	16-4-452-410-A011-B011 Center-to-Center length Extended: 36.3" (922mm) Compressed: 20.2" (512mm)	C16-10198	267	60
		C16-10944	356	80
		C16-15952	178	40
		C16-15953	445	100
		C16-28662	445	100
9	16-4-452-410-A011-B011 Center-to-Center length Extended: 36.3" (922mm) Compressed: 20.2" (512mm)	C16-22581	556	125
		C16-28663	667	150
		C16-28664	889	200
		C16-28665	1000	225
		C16-28666	1112	250

End Fittings

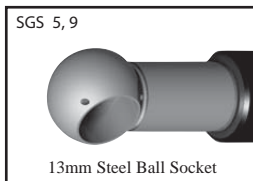
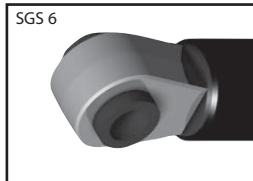
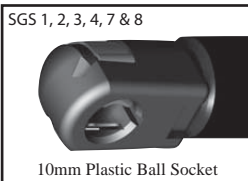

NOTE: SGS 1, SGS 2, SGS 3, SGS 4, SGS 7 and SGS 8 are available with 10mm diameter ball studs. Please specify part No. P67-00001 for 5/16-18 UNC 2A threads or part No. P67-00047 for M8 x 1.25-6G threads.

Available with P67-00002 13mm dia. ball 5/16-18 UNC-2A threads or P67-00116 13mm dia. ball M8X1.25-6G threads.
Requires two each: P68-00019 CLIP.

SERIES 16-2

Tube bodies are treated with a highly corrosion-resistant coating. The piston rods are induction-hardened prior to receiving a durable, black nitride surface.

Each SUSPA gas spring is manufactured with a specific quantity of oil, which serves both as a lubricant and damping medium. Relatively higher oil quantities increase damping and also increase the extended-to-compressed force ratio.

Maximum compressed forces will exceed extended forces by 30% to 80%, depending on internal oil quantity.

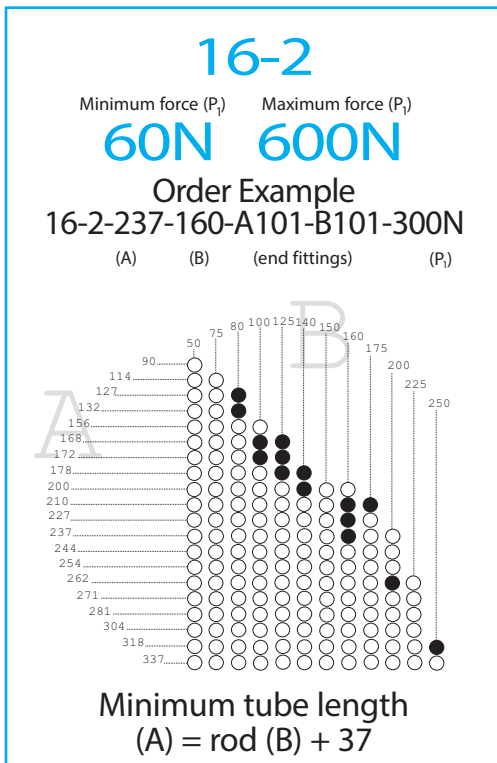

ALL DIMENSIONS IN MILLIMETERS

- INDEX: One inch = 25.4 millimeters
 One pound = 4.448 Newtons
 ○ = Available Combinations
 ● = Most Commonly Used
 *Custom sizes available, call for details.

Minimum and maximum forces are expressed in the extended position (P₁).

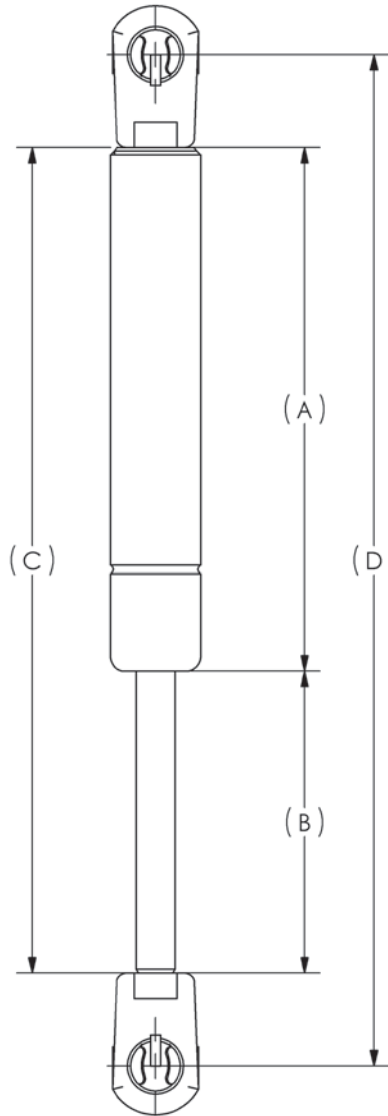

Minimum Tube Length	85
Maximum Tube Length	340
Tube Diameter	19mm
Rod Diameter	8mm
Thread Tube End	M6 x 1.0mm
Thread Rod End	M6 x 1.0mm

SERIES 16-3

Tube bodies are treated with a highly corrosion-resistant coating. The piston rods are induction-hardened prior to receiving a durable, black nitride surface.

Each SUSPA gas spring is manufactured with a specific quantity of oil, which serves both as a lubricant and damping medium. Relatively higher oil quantities increase damping and also increase the extended-to-compressed force ratio.

Maximum compressed forces will exceed extended forces by 30% to 80%, depending on internal oil quantity.

16-3

Minimum force (P₁) Maximum force (P₂)

100N 600N

Order Example

16-3-262-200-A285-B144-400N

(A) (B) (end fittings) (P₁)

A

129	50	80	100	125	150	160	175	200	225	250
○	○	○	○	○	○	○	○	○	○	○
○	○	○	○	○	○	●	○	○	○	○
○	○	○	○	○	○	○	○	○	○	○
○	○	○	○	○	○	○	○	○	○	○
○	○	○	○	○	○	○	○	○	○	○

B

Minimum tube length
(A) = rod (B) + 37

ALL DIMENSIONS IN MILLIMETERS

- INDEX: One inch = 25.4 millimeters
 One pound = 4.448 Newtons
 ○ = Available Combinations
 ● = Most Commonly Used
 *Custom sizes available, call for details.

Minimum and maximum forces are expressed in the extended position (P₁).

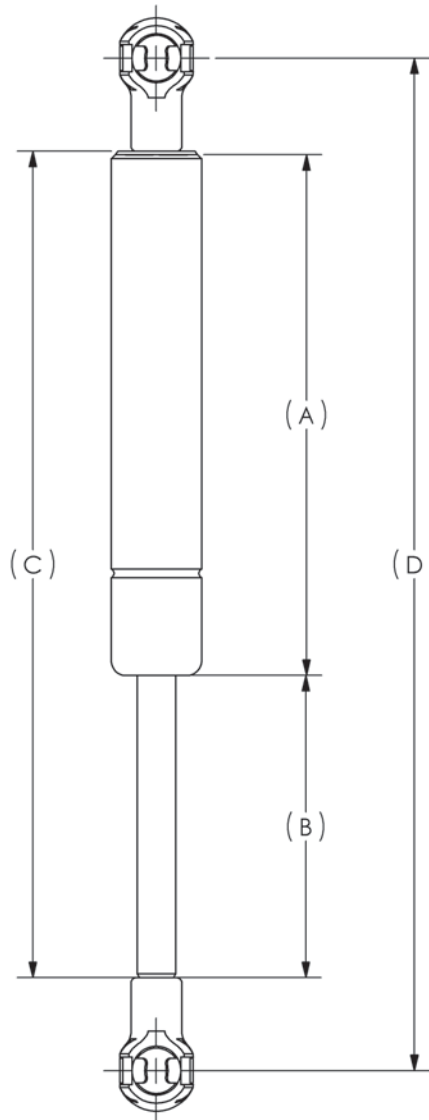

Minimum Tube Length	85
Maximum Tube Length	535
Tube Diameter	22mm
Rod Diameter	8mm
Thread Tube End	M8 x 1.25mm
Thread Rod End	M6 x 1.00mm

SERIES 16-4

Tube bodies are treated with a highly corrosion-resistant coating. The piston rods are induction-hardened prior to receiving a durable, black nitride surface.

Each SUSPA gas spring is manufactured with a specific quantity of oil, which serves both as a lubricant and damping medium. Relatively higher oil quantities increase damping and also increase the extended-to-compressed force ratio.

Maximum compressed forces will exceed extended forces by 30% to 80%, depending on internal oil quantity.

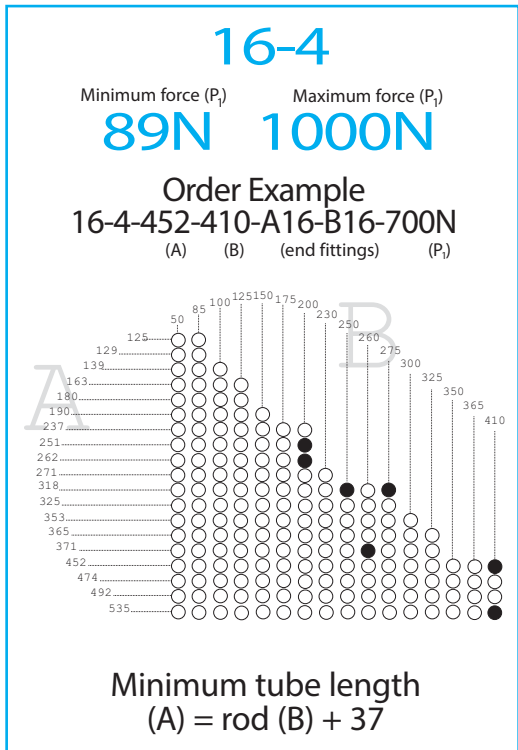

ALL DIMENSIONS IN MILLIMETERS

INDEX: One inch = 25.4 millimeters

One pound = 4.448 Newtons

○ = Available Combinations

● = Most Commonly Used

*Custom sizes available, call for details.

Minimum and maximum forces are expressed in the extended position (P₁).

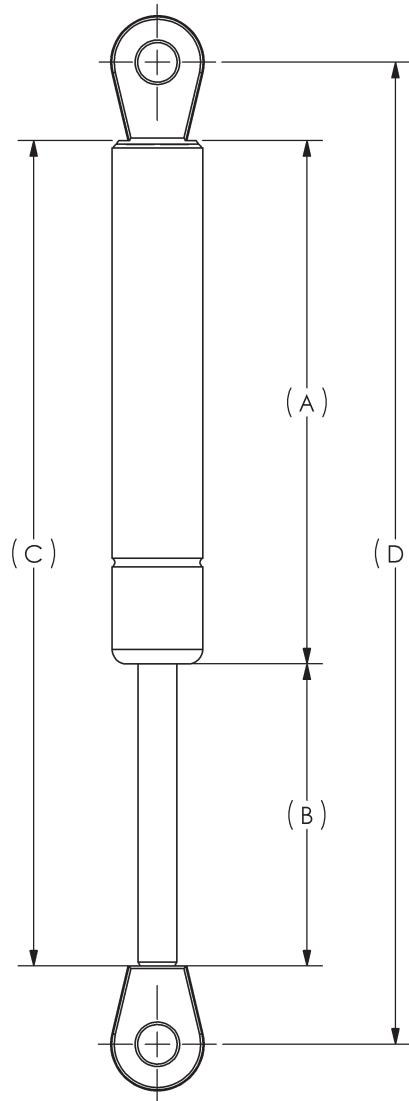

Minimum Tube Length	85
Maximum Tube Length	535
Tube Diameter	22mm
Rod Diameter	10mm
Thread Tube End	M8 x 1.25mm
Thread Rod End	M8 x 1.25mm



SERIES 16-6

Tube bodies are treated with a highly corrosion-resistant coating. The piston rods are induction-hardened prior to receiving a durable, black nitride surface.

Each SUSPA gas spring is manufactured with a specific quantity of oil, which serves both as a lubricant and damping medium. Relatively higher oil quantities increase damping and also increase the extended-to-compressed force ratio.

Maximum compressed forces will exceed extended forces by 30% to 80%, depending on internal oil quantity.

16-6

Minimum force (P₁) Maximum force (P₂)

200N 2200N

Order Example

16-6-474-400-A73-B73-1100N

(A) (B) (end fittings) (P₁)

B

	100	150	200	250	300	350	400	450	500
168	●	○	○	○	○	○	○	○	○
218	○	●	○	○	○	○	○	○	○
268	○	○	●	○	○	○	○	○	○
318	○	○	○	●	○	○	○	○	○
368	○	○	○	○	○	●	○	○	○
418	○	○	○	○	○	○	○	○	○
474	○	○	○	○	○	○	○	○	○
568	○	○	○	○	○	○	○	○	○

Minimum tube length for stroke ≤ 300
(A) = rod (B) + 43

Minimum tube length for stroke > 300
(A) = rod (B) + 55

ALL DIMENSIONS IN MILLIMETERS

- INDEX: One inch = 25.4 millimeters
 One pound = 4.448 Newtons
 ○ = Available Combinations
 ● = Most Commonly Used

Minimum and maximum forces are expressed in the extended position (P₁).

This product is manufactured in Germany and requires longer lead times.

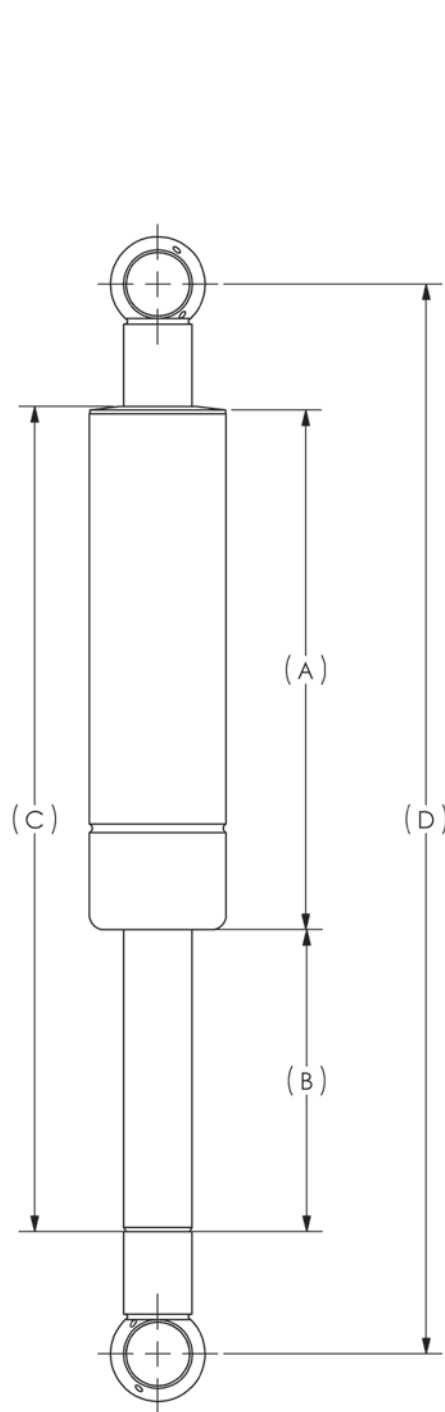

Minimum Tube Length	118
Maximum Tube Length	668
Tube Diameter	28mm
Rod Diameter	14mm
Thread Tube End	M8 x 1.25mm
Thread Rod End	M8 x 1.25mm

STAINLESS STEEL

Piston rods material - SAE 304 stainless steel with chrome plating.

Custom tube lengths available upon request. (minimum tube length = stroke length + 37mm)

Clevis end fitting available in stainless steel.

Stainless steel ball sockets available upon request.

Ball socket or clevis end fittings available in grey glass filled nylon.

Other end fittings available in zinc with clear finish upon request.

Gas spring can be made with standard hydraulic oil or with silicone oil.



End Fittings:

16-2 = M6 Threads

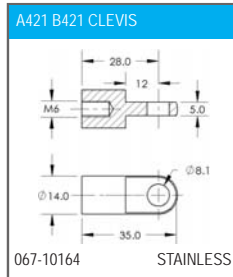
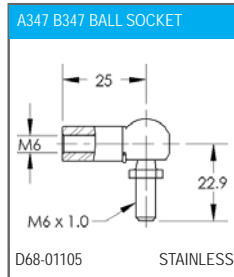
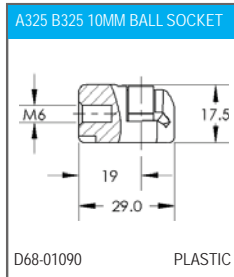

Model Description	Rod Diameter	Tube Diameter	Thread Size	Compressed Length	Extended Length	Stroke	Force
16-2							
X16-2-132-80-AM6-BM6	8mm	17.5mm	M6X1.0	138mm	218mm	80mm	60-600N
X16-2-172-100-AM6-BM6	8mm	17.5mm	M6X1.0	172mm	272mm	100mm	60-600N
X16-2-201-150-AM6-BM6	8mm	17.5mm	M6X1.0	201mm	351mm	150mm	60-600N
X16-2-237-160-AM6-BM6	8mm	17.5mm	M6X1.0	237mm	397mm	160mm	60-600N
X16-2-263-200-AM6-BM6	8mm	17.5mm	M6X1.0	263mm	463mm	200mm	60-600N

End Fittings:

16-4 = M8 Threads

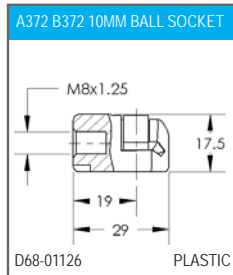
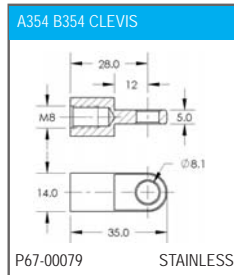
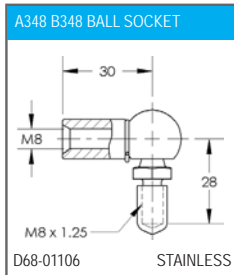

Model Description	Rod Diameter	Tube Diameter	Thread Size	Compressed Length	Extended Length	Stroke	Force
16-4							
X16-4-129-85-AM8-BM8	10mm	20.6mm	M8X1.25	129mm	214mm	85mm	100-1000N
X16-4-262-200-AM8-BM8	10mm	20.6mm	M8X1.25	262mm	462mm	200mm	100-1000N
X16-4-337-300-AM8-BM8	10mm	20.6mm	M8X1.25	337mm	637mm	300mm	100-1000N
X16-4-452-410-AM8-BM8	10mm	20.6mm	M8X1.25	452mm	862mm	410mm	100-1000N

HYDRO-STRUT 29-4

Tube bodies are treated with a highly corrosion-resistant coating. The piston rods are induction-hardened prior to receiving a durable, black nitride surface.

Each SUSPA gas spring is manufactured with a specific quantity of oil, which serves both as a lubricant and damping medium. Relatively higher oil quantities increase damping and also increase the extended-to-compressed force ratio.

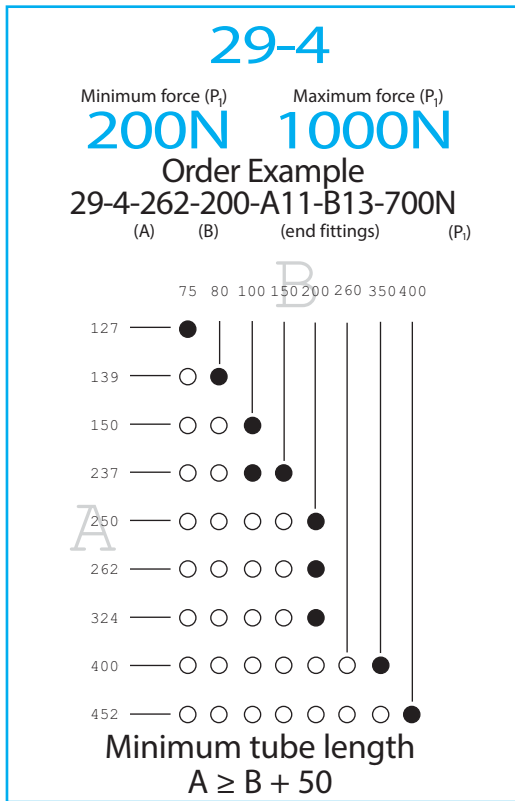

ALL DIMENSIONS IN MILLIMETERS

INDEX: One inch = 25.4 millimeters

One pound = 4.448 Newtons

○ = Available Combinations

● = Most Commonly Used

Minimum and maximum forces are expressed in the extended position (P₁).

Blocking on compression is available in light (200N), medium (400-600N) or heavy (800-1000N). Please specify.

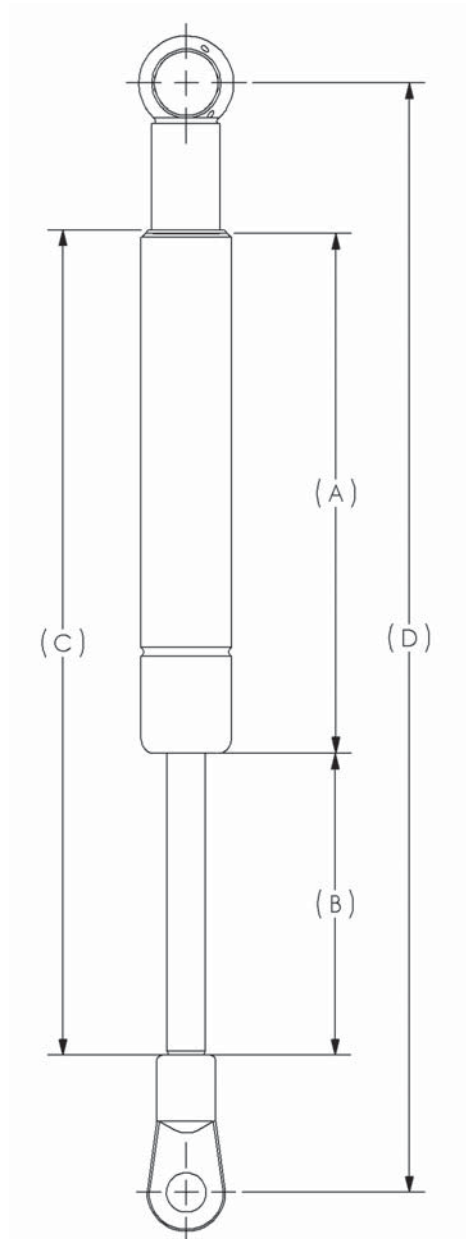

Minimum Tube Length	127
Maximum Tube Length	452
Tube Diameter	22mm
Rod Diameter	10mm
Thread Tube End	M8 x 1.25mm
Thread Rod End	M8 x 1.25mm



DAMPERS

16-1, 16-2, 16-3, 16-4

Standard Dampers

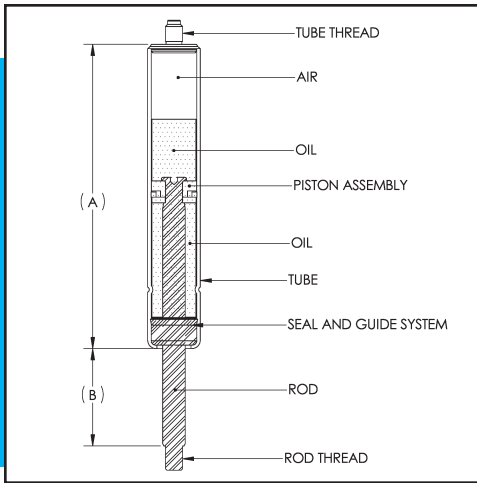

Standard non-pressurized dampers are designed for low force, motion control applications. The dampers are filled with a combination of oil and air. The ratio between the oil and the air effects the amount of dampened stroke length. *Idle stroke is present because the oil and the air are not separated. This type of damper is ideal for applications that do not utilize the entire stroke length or require constant damping in one direction only.

Characteristics

- Available in all 16 Series sizes.
- No extension force.
- Idle stroke.*
- Mounting position- Piston rod down.
- Damping available on extension, compression or both.
- Damping force may vary with different orifices and oil viscosity.

Dampers with Base Valve

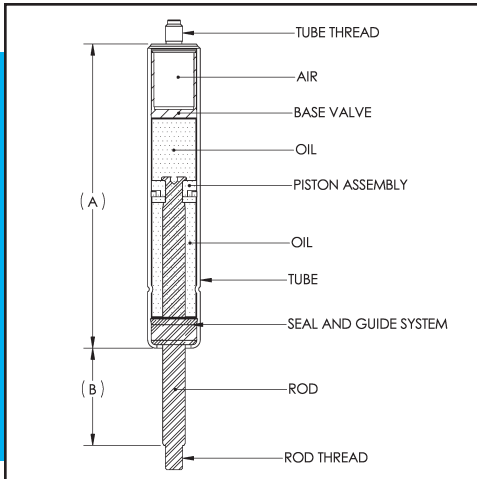

This damper is very similar to the standard damper with an added component. A base valve is inserted into the bottom of the tube to separate the air from the oil. The base valve eliminates the *idle stroke that is present in standard dampers. This leads to a smoother, more consistent damping force along the entire stroke length.

Characteristics

- Only available in 16-2 Series.
- No extension force.
- Minimal idle stroke.*
- Mounting position- Piston rod down.
- Damping available on extension, compression or both.
- Damping force may vary with different orifices and oil viscosity.

Dampers with Base Valve and Accumulator

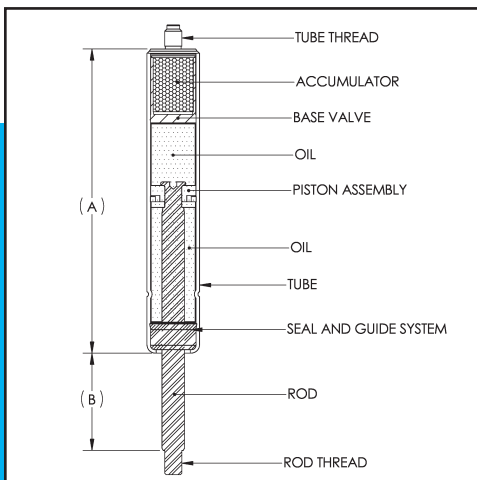

A foam accumulator is inserted in the base valve to replace the air. The accumulator contracts and expands when the damper is compressed or extended to accommodate the rod volume change. This allows the damper to be mounted horizontally or vertically. The function of the accumulator produces a damper that provides consistent damping force along the entire stroke length.

Characteristics

- Only available in 16-2 Series.
- No extension force.
- Minimal idle stroke.*
- Mounting position- Horizontal or vertical regardless of piston rod orientation.
- Damping available on extension, compression or both.
- Damping force may vary with different orifices and oil viscosity.

Series		16-1	16-2	16-3	16-4
DIMENSIONS	Rod Length (B)	25-175mm	50-285mm	50-285mm	50-500mm
	Rod Diameter	6mm	8mm	8mm	10mm
	Thread Rod End	M6x1.0mm	M6x1.0mm	M6x1.0mm	M8x1.25mm
	Tube Length (A)	61-225mm	85-340mm	85-535mm	85-535mm
	Min. Tube Length (A)=Rod(B) +	27mm	**37-114mm	37mm	37mm
	Tube Diameter	15mm	19mm	22mm	22mm
	Thread Tube End	M6x1.0mm	M6x1.0mm	M8x1.25mm	M8x1.25mm

**Minimum tube length depends on base valve chosen.

*Idle Stroke: Area of reduced damping caused by the air pocket compressing or by air and oil mixing.

END FITTINGS M6

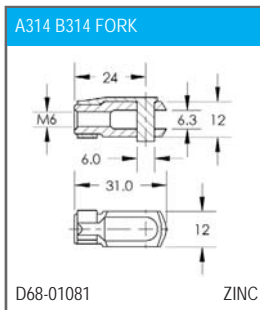
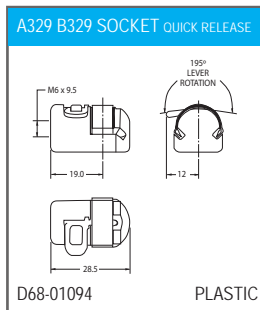
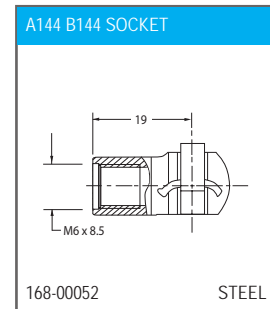
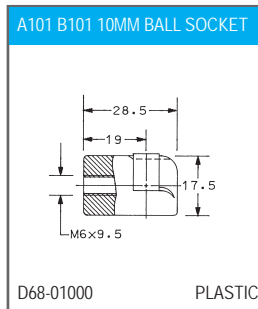
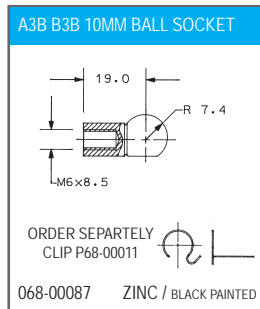
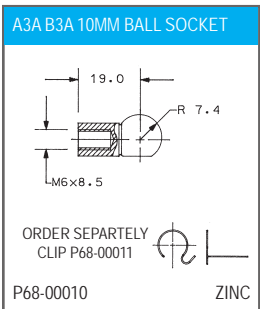
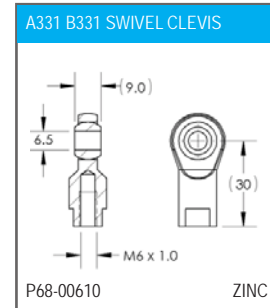
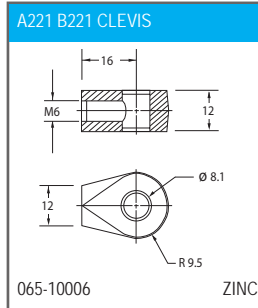
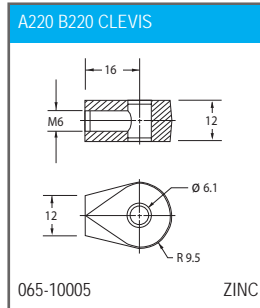
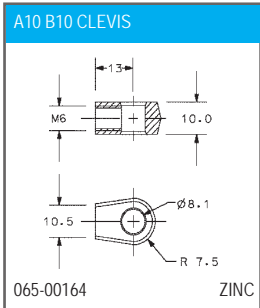
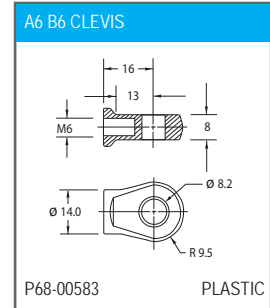
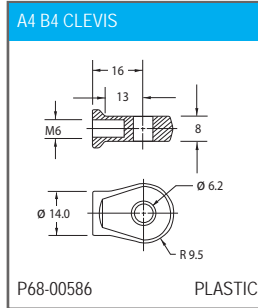
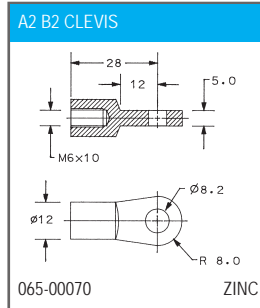
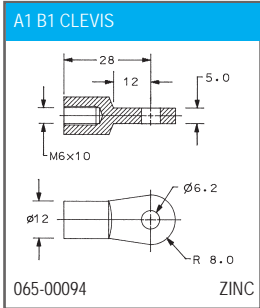

	TUBE DIAMETER	ROD DIAMETER	THREAD SIZE	
			TUBE	ROD
16-1	15 mm	6 mm	M6 x 1.0mm	M6 x 1.0mm
16-2	19 mm	8 mm	M6 x 1.0mm	M6 x 1.0mm
16-3	22 mm	8 mm	M8 x 1.25mm	M6 x 1.0mm
16-4	22 mm	10 mm	M8 x 1.25mm	M8 x 1.25mm
16-6	28 mm	14 mm	M8 x 1.25mm	M8 x 1.25mm
29-4	22 mm	10 mm	M8 x 1.25mm	M8 x 1.25mm

Unless noted, all threads are Class 6G (external) and 6H (internal).

A = Fitting placed on tube end. B = Fitting placed on rod end.

- All fittings are interchangeable to either end (except some 16-3 series)
- All dimensions are nominal and are expressed in millimeters.
- Welded retainers compatible on all series.

END FITTINGS M8

A11 B11 13MM BALL SOCKET

ORDER SEPARTELY
CLIP P68-00019

097-00087 ZINC

A14 B14 10MM BALL SOCKET

ORDER SEPARTELY
CLIP P68-00011

068-00006 ZINC

A198 B198 10MM BALL SOCKET

D68-01030 PLASTIC

A285 B285 10MM BALL SOCKET

168-00055 STEEL

A321 B321 13MM BALL SOCKET

P68-00034 STEEL

A332 B332 SOCKET QUICK RELEASE

D68-01095 ZINC

A13 B13 CLEVIS

065-00071 ZINC

A16 B16 CLEVIS

D68-01006 ZINC / PLASTIC BUSHING

A20 B20 CLEVIS

065-00191 ZINC

A26 B26 CLEVIS

065-00029 ZINC

A30 B30 CLEVIS

065-00155 ZINC

A31 B31 CLEVIS

065-00145 ZINC

A330 B330 SWIVEL CLEVIS

P68-00627 ZINC

A21 B21 FORK

068-00124 ZINC

WELDED ENDS M6 OR M8

A23 B23 WELDED RETAINER

058-00237 STEEL / BLACK PAINTED

A49 B49 WELDED RETAINER

P68-00506 STEEL / BLACK PAINTED

A61 B61 WELDED RETAINER

P68-00513 STEEL / BLACK PAINTED

A64 B64 WELDED RETAINER

P68-00514 STEEL / BLACK PAINTED

A91 B91 WELDED RETAINER

P68-00570 STEEL / BLACK PAINTED

END FITTINGS

BALL STUD & BRACKET

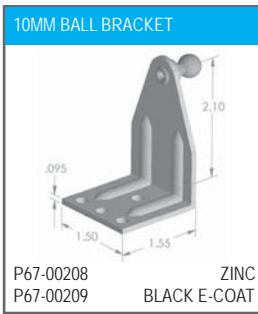
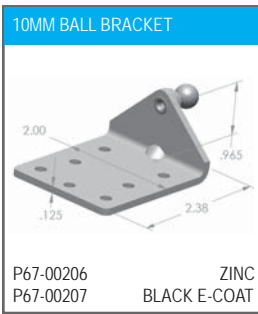
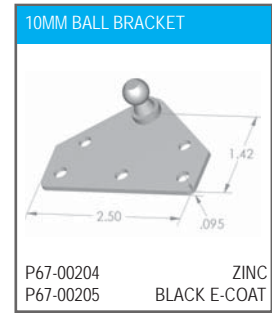
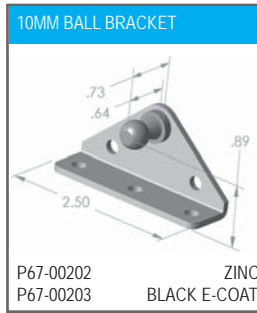
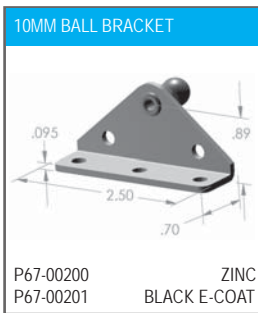
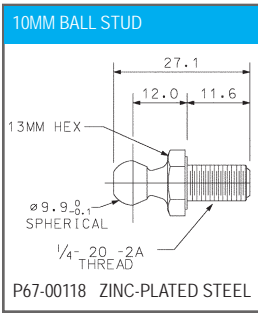
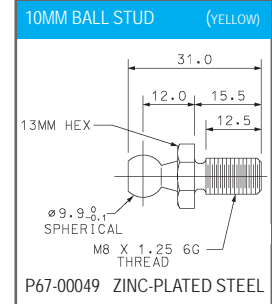
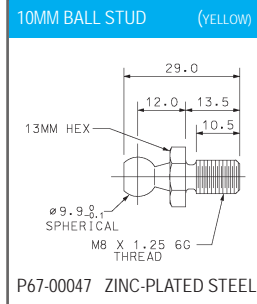
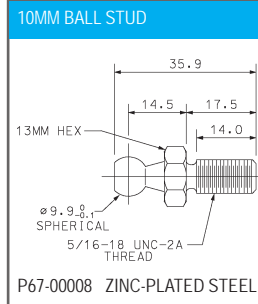
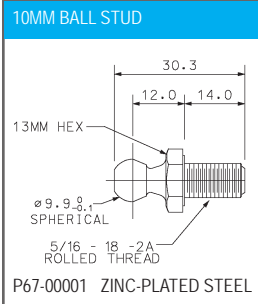

- SUSPA's 16-1, and 16-2 gas springs have M6 threads.
- SUSPA's 16-4 gas springs have M8 threads.
- Brackets not recommended for gas spring forces over 445N (100lbs.)
- Brackets mounting holes are .20"

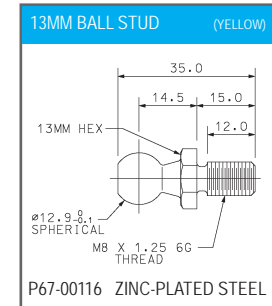
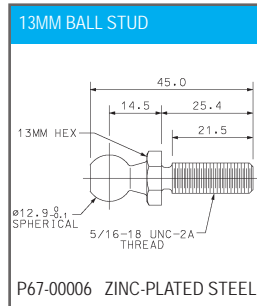
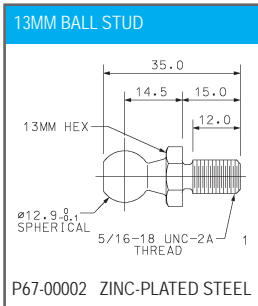
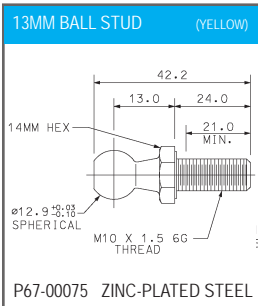

Storage, Disposal Guidelines

The proper storage of SUSPA gas springs contributes to their performance and life expectancy. This includes protecting them from moisture, spray, salt water, dirt and mechanical damage.

Horizontal or vertical storage is acceptable for up to three months. Beyond this time, gas springs should be stored vertically with the piston rod pointing downward.

Maximum storage without actuation should be limited to 12 months. An increased release force at first actuation after storage is possible.

Temperatures during storage should not range beyond -10°C (14°F) to $+60^{\circ}\text{C}$ (140°F). The range may be extended during a short period (transportation), but condensation can damage the cylinders.

Optimal relative humidity is approximately 50%.

Use the original packaging from the SUSPA factory for the best storage environment.

All SUSPA gas springs are 100% recyclable.

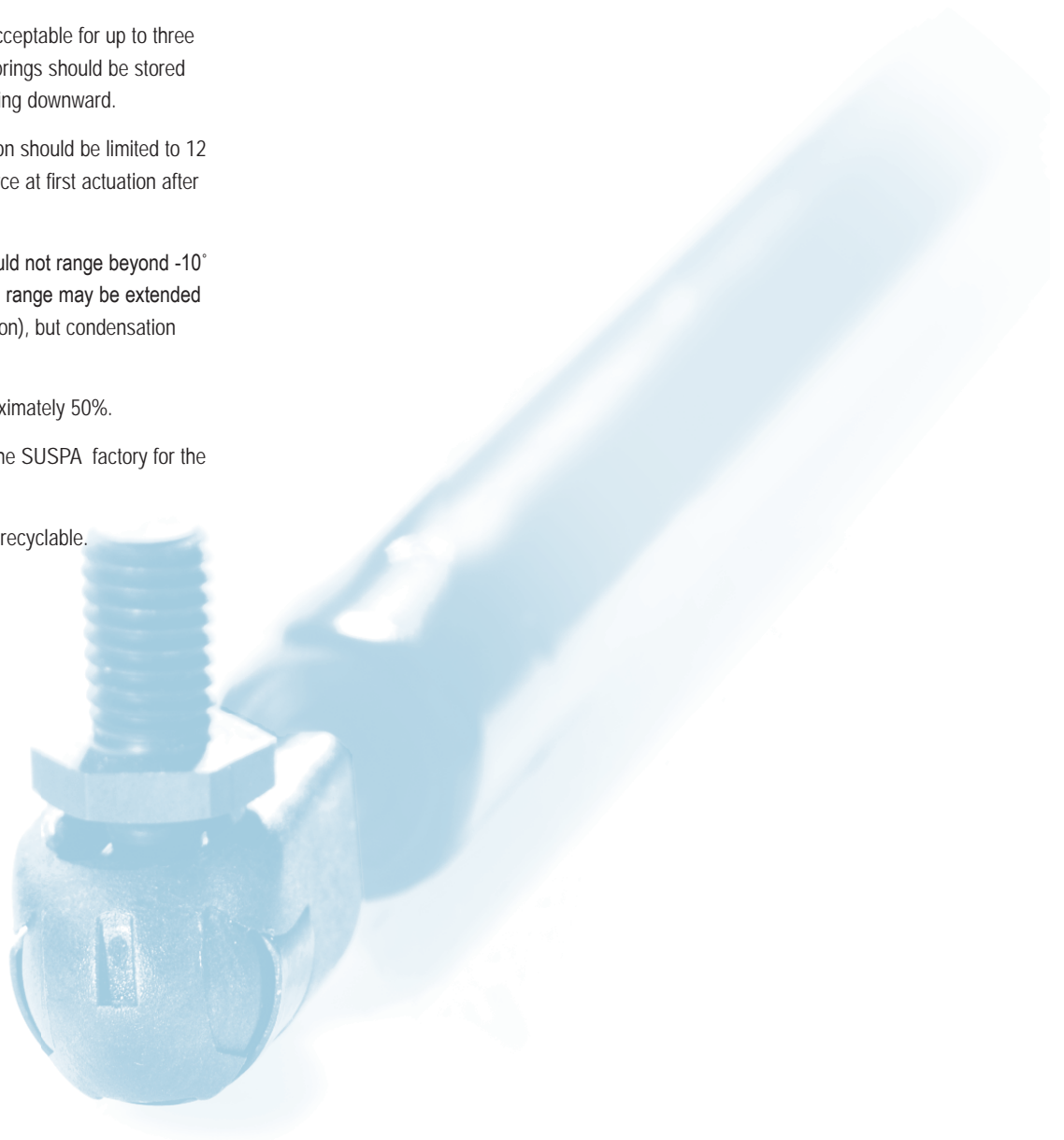



SUSPA[®]

SUSPA, Incorporated
3970 Roger Chaffee Dr. SE
Grand Rapids, MI 49548-3497
P 616-241-4200 F 616-531-3310
E-mail: sim@us.suspa.com
www.suspa.com

LIT-00106 0715-1500

Copyright 2015