



[www.FGWilson.com](http://www.FGWilson.com)



## FG Wilson Control Systems

# Contents

- 1002T Analogue Control Panel
- FG Wilson DCP-10 and DCP-20 Digital Control Panels
- PowerWizard 1.1, 1.1+ and 2.1 Digital Control Panels
- PowerWizard Remote Monitoring Options
- PowerWizard Remote Monitoring and Control Options
- easYgen – 2500 Synchronising Control Panel
- easYgen – 3200 Synchronising Control Panel
- easYgen Control Panel Options – NetBiter FGW200
- easYgen Control panel Options – I/O Expansion Module
- Load Transfer Panels
- CTI Panel Features
- ATI Panel Features
- Features and Options

# FG Wilson Control Systems

## Putting You in Control

Whatever your power requirements, FG Wilson can provide a control system to suit your needs. Our generator set experts design and validate FG Wilson control systems to optimise your generator set performance and put you in control.

All FG Wilson control panels are compact, versatile and easy to use. Our comprehensive range includes key-start analogue control panels for straightforward functionality and reliability; digital control panels suitable for use in mains failure applications, providing advanced metering, protection and diagnostics; and the next generation of advanced synchronising panels with integrated load management capability, suitable for synchronising up to 32 generator sets.

Our range of load transfer panels are designed to enhance the operation of your standby generator set in conjunction with our electronic control panels, to provide automatic control of your standby generator set in the event of a power outage, 24 hours a day, 365 days a year.

For more challenging power requirements, our Power Solutions Team is dedicated to the design and production of bespoke control systems to meet your individual needs, regardless of complexity.



# 1002T

## Analogue Control Panel

The 1002T Control Panel is equipped with all the necessary generator set instrumentation and protection devices, whilst providing the straightforward functionality and reliability of a key-start panel.

### 1002T



### Benefits

- Simplified monitoring of generator set conditions at a glance
- Heavy duty, reliable industrial push buttons and switches
- Visual individual warning and shutdowns through LED's
- Universal pictorial fault lamp indicators

### Features

- Analogue metering: voltmeter, ammeter, hours-run counter, combined frequency and tachometer
- 7 position voltmeter phase selector switch
- 4 position ammeter phase selector switch
- Preheat (start aid active LED indicator)
- DC supply from starting battery protected by MCB's
- Printed circuit board assemblies
- Multi-pin plug and socket connections for ease of servicing
- Engine protection through critical shutdowns
- AC instruments are 90° deflection, flush mounted
- AC instruments in accordance with IEC60051 and 60529, DIN43700 and 43718, BSEN60051 and 61010, UL94

# FG Wilson DCP

## Digital Control Panels

The FG Wilson DCP range allows you to monitor and control your generator set with ease, providing important diagnostic information whilst ensuring your unit operates within safe parameters.

FG Wilson DCP digital control panels, provide simple, intuitive menu navigation and control of your generator set operations. Key information is displayed via the LCD screen and LED's using universally recognised symbols, eliminating the need for complex instructions or language settings.

## FG Wilson DCP-10 and DCP-20



FG Wilson DCP-10 is standard on  
5.5 – 220 kVA range

### Benefits

- Automatic start control module
- Integrated metering & controls
- Monitoring, protection, operational status, fault conditions and metering displayed via LCD & LED's
- Configuration of parameters via licence free software
- Robust electronics package
- Symbols for simple, intuitive control

### Features

- Configuration of parameters by front panel push buttons or by PC via mini USB interface (DCP-10) or communication software (DCP-20)
- True RMS Voltage Sensing
- Engine & AC monitoring
- Run / Auto keys with LED indicators
- Under / Over voltage protection
- Larger 128x64 graphic LCD (DCP-20 only)
- RS485, RS232 or USB port for remote communication (DCP-20 only)
- Power metering (DCP-20 only)

# PowerWizard

## Digital Control Panels

### PowerWizard – Providing safe control of your generator set

The FG Wilson PowerWizard range of digital control panels, combine straightforward menu navigation with advanced metering and protection technology. They are used in automatic mains failure applications in conjunction with transfer panels.

Our PowerWizard range allows you to monitor and control your generator set with ease, whilst ensuring your unit operates within safe parameters and provides important diagnostic information when needed.

## PowerWizard 1.1, 1.1+ and 2.1



PowerWizard 1.1+ is standard on  
275 – 2500 kVA range

### Benefits

- Robust electronics package for industry leading reliability
- Single menu layout for ease of navigation and monitoring with shortcut keys for immediate access to engine or AC metering
- 10.5-32V DC providing a single module to cover the whole FG Wilson generator set range
- Comprehensive range of standard features and options to ensure the most appropriate configuration for your needs
- Serviced using standard EST

### Features

- True RMS Voltage Sensing
- CAN 1 Data Link for communication to electronic engines, CAN 2 (2.1 only) Accessory Data Link for additional modules
- 40 unique events log configuration including first, last and number of occurrences and real time clock
- Engine and AC Monitoring
- Two display languages (Customer Language & Technician Language)
- Up to 5 spare fault channels
- Configurable sender input
- Dedicated key to reset all faults and main menu short cut key
- Run/Auto/Stop keys with LED indicators
- Integrated metering and controls reducing components and wiring, aiding reliability and ease of service
- Generator set voltage and over / under frequency protection (1.1+ and 2.1 only)
- MODBUS connection to building management system via RS485 (2.1 only)
- Power metering (2.1 only)

# PowerWizard

## Remote Monitoring Options

### Remote Monitoring

The PowerWizard Annunciator is a 16-channel display unit for remotely monitoring the status of FG Wilson generator sets at a distance of up to 240 metres. The Annunciator communicates via the CAN 2 data link which comes as standard on generator sets fitted with the PowerWizard 2.1 Control Panel.

Each of the 16 channels on the Annunciator has two LEDs to display status and alarm signals directly from the PowerWizard 2.1 Control Panel on the generator set.

The pre-set channels linked to each LED display can be individually configured using the Electronic Service Tool (EST). This allows Operators to monitor different generator set status and alarm signals to suit site-specific requirements.

In addition to the LED display, the Annunciator includes an audible alarm, an alarm acknowledge pushbutton and a lamp test pushbutton.



PW Panel	Option Codes	Annunciator Dimensions		
		A mm (in)	B mm (in)	C mm (in)
PW 2.1	ANN16	158 (6.22)	130 (5.12)	288 (11.34)

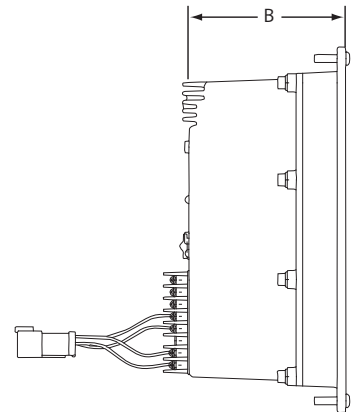
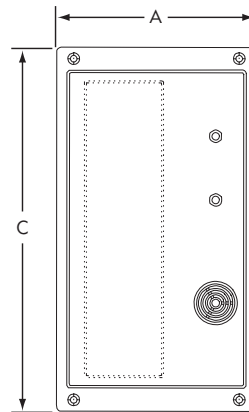



# PowerWizard

## Remote Monitoring and Control Options

### Remote Monitoring and Control

The FG Wilson Communications Interface Module and Software Package allows operators to monitor and control all generator set functions from a virtual control panel on their PC.

Depending on the operator's distance from the generator set and the type of connection available to link to the generator set, two options are offered:

- For distances up to 1,000 metres, where it is convenient to have a hard-wired connection, a generator set can be monitored using the Communications Interface Module and Software Package on the operator's PC or laptop.
- Alternatively, when laying a hard-wired connection is not convenient, the same monitoring and control functionality is available, but communication between the operator's PC or laptop and the Control Panel is made through a modem and the telephone network. Depending on the operator's distance from the generator set and the type of connection available to link to the generator set, two options are offered:

Connection Via	Panel Option Codes
	<b>PW2.1</b>
Hand-wired Connection (Up to 1,000m)	REM 1
Telephone Network	REM 2*

\* Modem to link the operator's PC or laptop with the telephone network is not included.

**Note:** PC or laptop is not included in any of the above options.

Additional remote monitoring and control options, via the internet, GSM and GPRS are available with PowerWizard 2.1 Control Panels. Please contact your local FG Wilson Dealer for further information.

#### Using Hard-wired Connection

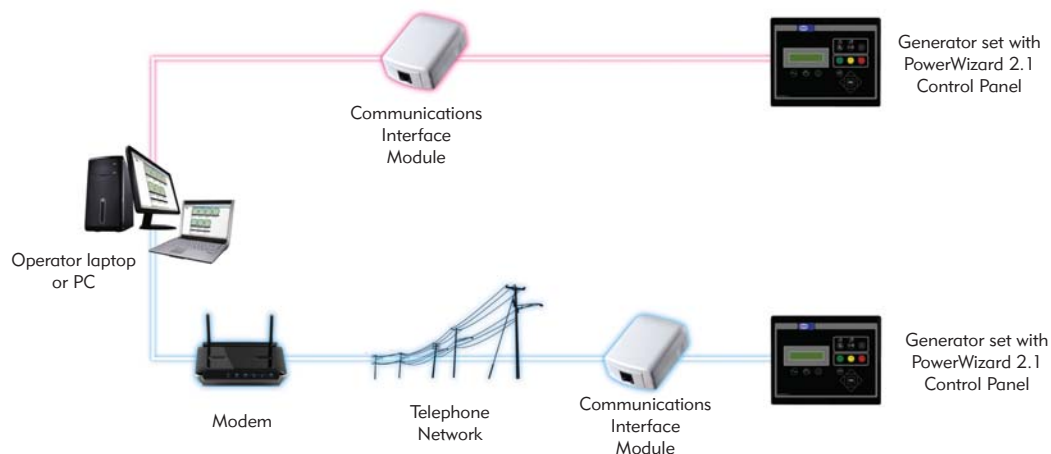

#### Using Telephone Network



# easYgen-2500

## Synchronising Control Panel

The easYgen-2500 offers industry leading power management and control

The easYgen-2500 is a generator set-to-set controller for paralleling and load sharing applications of up to 16 generator sets. A special feature of the easYgen-2500 is the enhanced load sharing system. This provides advanced generator load dependent start / stop functionality with automatic generator set selection to ensure optimal system efficiency.

## easYgen-2500



### Benefits

- Capable of set-to-set synchronising for up to 16 generator sets
- User friendly interface
- Easy system navigation via programmable soft keys
- Multiple communication protocols for communication with Engine Control Units (ECUs), external I/O boards, PLCs and modems
- Multilingual capability: English, Chinese, French, German, Italian, Japanese, Polish, Portuguese, Russian, Spanish and Turkish
- Capable of working with all common industrial interfaces

### Features

- Power and reactive power load sharing up to 16 units including load-dependent start / stop
- Engine start / stop and generator set measuring and protection
- Running hours balancing
- Breaker control: synchronization, open-close control, only-open control, breaker monitoring
- Dead bus closure negotiation
- PLC-like programming with Logics Manager
- 300-entry, time and date stamp log
- Operating hours / start / maintenance counters
- Configurable trip levels / delays / alarm classes
- Field configurable application settings
- Multi-level password protection

# easYgen-2500

## Protection

### Generator Set

- Over / under voltage
- Over / under frequency
- Dead bus detection
- Overload
- Reverse / reduced power
- Time over current
- Instantaneous over current
- Inverse time over current
- Phase rotation
- Unbalanced load
- Power factor

### Engine

- Over / under speed
- Battery over / under voltage
- Speed / frequency mismatch

## Inputs / Outputs (I/O)

- 3 phase true r.m.s. generator set current / power
- 1 speed input (magnetic / switching)
- 10 configurable discrete alarm inputs
- Five configurable analogue inputs
- Four configurable analogue outputs (+/- 10 V, +/- 20 mA, PWM; configurable)
- Two CAN bus interface (load share, Toolkit)
- 11 Relay Outputs Isolated
- RS485 Modbus interface
- Service Port (RS232 – Woodward DPC cable required)

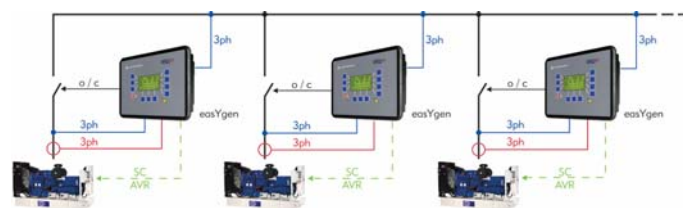
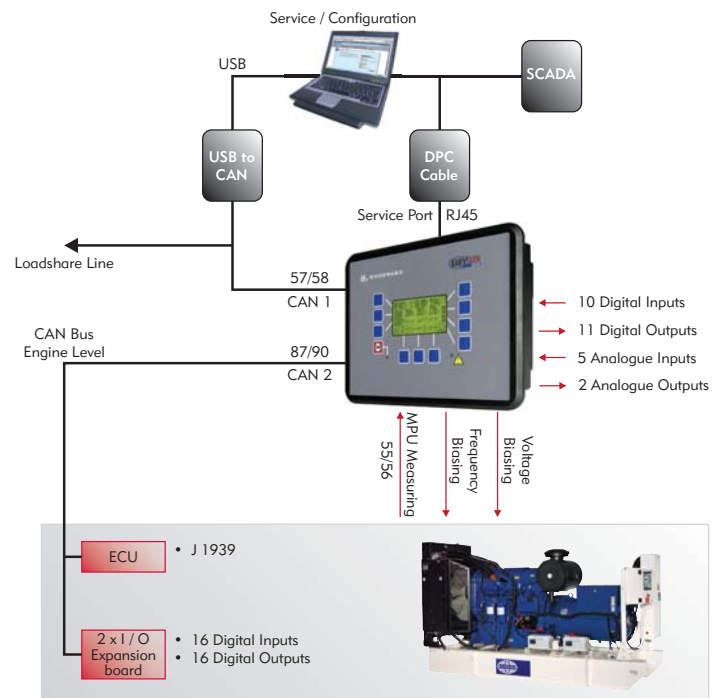

# easYgen-3200<sup>†</sup>

## Synchronising Control Panel

The easYgen-3200 offers industry leading power management and control

The easYgen-3200 is a versatile control unit, incorporating all the features of the easYgen-2500 including enhanced load sharing, and is adaptable to every application. Typical applications include co-generation, standby, AMF, peak shaving, import / export or distributed generation. This control panel is suitable for synchronising up to 32 generator sets running in island mode, mains parallel and multiple unit mains parallel operations.

## easYgen-3200



### Benefits

- Capable of generator set-to-set, set-to-mains and multiple set-to-mains synchronisation for up to 32 generator sets
- Enhanced system flexibility meets demanding customer specifications
- User friendly interface via 320x240 pixel graphical interactive 5.7" LCD
- Easy system navigation via programmable soft keys
- Multilingual capability: English, Chinese, French, German, Italian, Japanese, Polish, Portuguese, Russian, Spanish, Turkish and Finnish
- Multiple communication protocols for communication with Engine Control Units (ECUs), external I/O boards, PLCs and modems

### Features

- Power and reactive power load sharing up to 32 units including load-dependent start / stop
- Engine start / stop and generator set measuring and protection
- Automatic base loading
- Running hours balancing
- Import / export control
- Dead bus closure negotiation
- ECU monitoring and alarm management as well as remote start / stop and control commands
- PLC-like programming with Logics Manager
- 300-entry, time and date stamp log
- Operating hours / start / maintenance counters
- Configurable trip levels / delays / alarm classes
- Field configurable application settings
- Multi-level password protection
- RP3000 remote display panel available for management and control from adjacent plant room

<sup>†</sup> Available through Power Solutions

# easYgen-3200

## Protection

### Generator Set

- Over / under voltage and frequency
- Dead bus detection
- Overload
- Unbalanced load
- Reverse / reduced power
- Time over current
- Instantaneous over current
- Measured ground fault
- Phase rotation
- Power factor

### Engine

- Over / under speed
- Battery over / under voltage
- Auxiliary excitation
- Speed / frequency mismatch

### Mains

- Over / under voltage and frequency
- Phase shift
- Rotation field

## Inputs / Outputs (I/O)

- Two separate sets of 3-phase true r.m.s. voltage measuring inputs for the generator set and mains, and 2-phase busbar voltage
- 3-phase true r.m.s. generator set current / power
- 1-phase true r.m.s. current input freely configurable
- 1 speed input (magnetic / switching)
- 10 configurable discrete alarm inputs

- Up to 12 programmable discrete outputs
- Three configurable analogue inputs
- Two configurable analogue outputs
- Two CAN bus communication networks (up to 32 participants, isolated)
- Two serial ports supporting Modbus RTU Protocol, RS-485 and RS-232 (isolated)

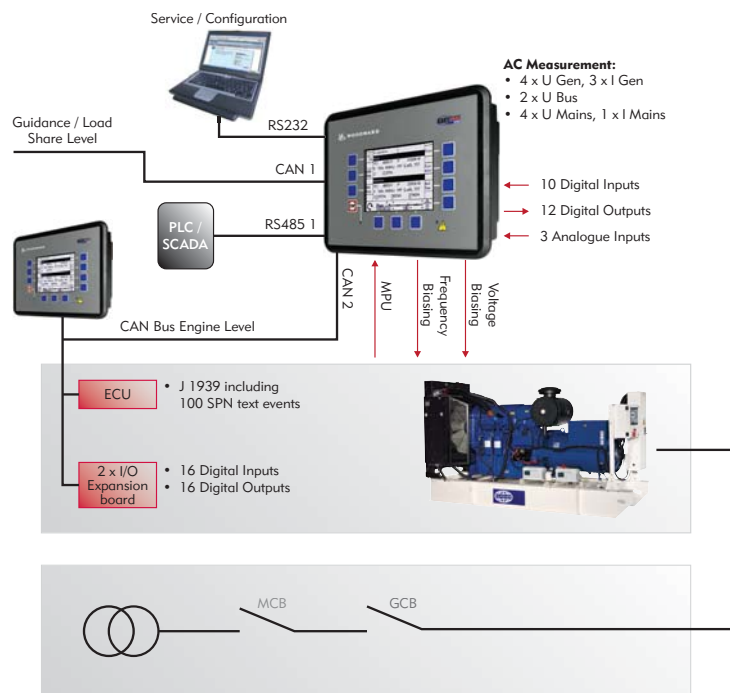

# easYgen Control Panel Options

## NetBiter® FGW200

### Remote management for new and existing generator set installations

With software designed exclusively for FG Wilson, the FGW200 offers new opportunities for remote access over the internet and mobile phone. The NetBiter unit is suitable for use in new and existing installations due to control panel Auto Detect software which offers plug and play capability.



### Remote management that takes customer service to a new level by:

- Reducing the need to travel to remote sites for maintenance purposes
- Minimising downtime with instant information about equipment health
- Theft prevention through generator set tracking
- Fuel level monitoring to optimise fuel inventory
- Start up logging to help prevent generator set misuse
- Allowing multiple project and device management through NetBiter.net

### Features

- New Auto Detect software allows retrofit to PowerWizard 2.1, easYgen-2500, easYgen-3200 control panels and ATI transfer panels
- Built in web interface for data monitoring
- Built in alarm manager for SMS, email and SNMP
- Built in data logger of historical trends
- GSM / GPRS modem included
- All software included, easily upgraded remotely and provided with no licensing cost

# easYgen Control Panel Options

## I/O Expansion Module<sup>†</sup>

Connection to and from external system devices enabling more flexibility to meet your specific power requirements.

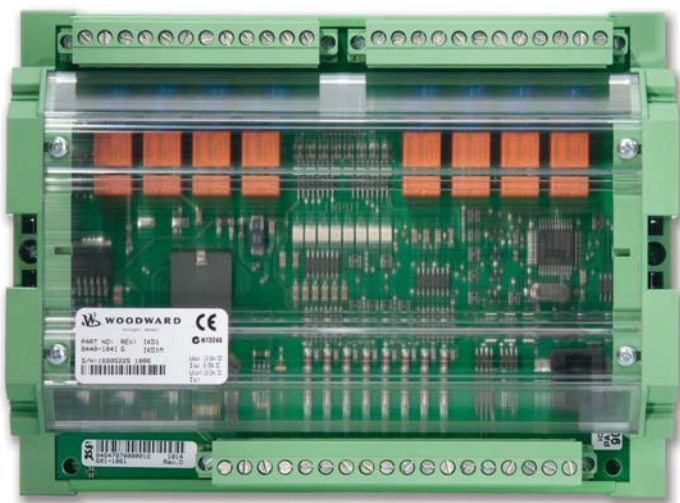

## Features

- 8 configurable discrete alarm inputs
- 8 configurable relay outputs
- Connection to easYgen control panel via CAN bus
- Input and output configuration via onboard easYgen relay manager
- Remote control of output relays via CAN bus
- The I/O Expansion Module can be used with other manufacturer's controls. Consult Woodward product manual 37135 for information regarding the address assignments of the CAN bus interface

<sup>†</sup> Available through Power Solutions



# Load Transfer Panels

## 24 Hour Power Protection 365 days a year...

FG Wilson's range of intelligent Load Transfer Panels offer you peace of mind.

The FG Wilson Load Transfer Panel range offers an electronically controlled response to power outages. With flexible, upgradeable options and a high level of functionality FG Wilson transfer panels provide 24-hour automatic control of standby generator sets, 365 days a year.

## Load Transfer Panel Range



### Benefits

- Fully automatic mains failure sensing and generator set start signal
- Pre-programmed enabling the panel to run on installation with the ability to customise if necessary
- Fast acting switches reduce transfer times between set and utility power
- Available from 63 – 3200A
- Seamless integration with FG Wilson digital control panels

### Features

- Automatic and manual operation
- Automatically provides generator set start signal upon detection of mains failure, overvoltage or loss of phase
- Automatic mains re-transfer function
- Flexible, upgradeable options
- Test operations and sequences accessible from panel or remotely
- Manual switch operation possible via external handle
- LED functions display showing generator set / mains availability and switch position
- LCD display for voltage and timers
- Load transfer panel range meets ATS IEC 60947-6-1 standard

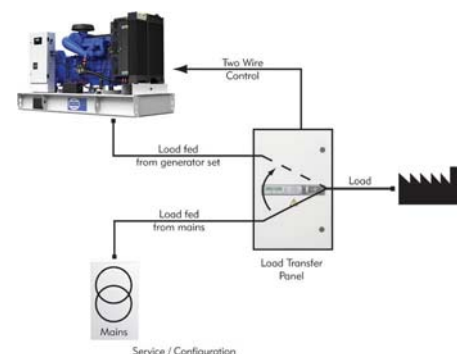



# Load Transfer Panels

Model	Rating	ATI Transfer Dimensions			Weight
		A mm (in)	B mm (in)	C mm (in)	
CTI 63	63A	600 (23.6)	400 (15.7)	200 (7.9)	19 (41.8)
CTI 100	100A	600 (23.6)	400 (15.7)	200 (7.9)	19 (41.8)
CTI 125	125A	600 (23.6)	400 (15.7)	200 (7.9)	19 (41.8)
CTI 160	160A	600 (23.6)	400 (15.7)	200 (7.9)	19 (41.8)

Model	Rating	ATI Transfer Dimensions			Weight
		A mm (in)	B mm (in)	C mm (in)	
ATI 250	250A	500 (19.7)	600 (23.6)	300 (11.8)	39 (86.0)
ATI 400	400A	600 (23.6)	600 (23.6)	375 (14.7)	44 (97.0)
ATI 630*	630A	900 (35.4)	600 (23.6)	475 (18.7)	66 (145.5)
ATI 800*	800A	1100 (43.3)	775 (30.5)	650 (25.6)	125 (275.6)
ATI 1000*	1000A	1100 (43.3)	775 (30.5)	650 (25.6)	130 (286.6)
ATI 1250*	1250A	1400 (55.1)	1005 (39.6)	650 (25.6)	230 (507.1)
ATI 1600*	1600A	1600 (63.0)	1005 (39.6)	800 (31.5)	330 (727.7)
ATI 2000*	2000A	1899 (74.8)	1005 (39.6)	1007 (39.6)	400 (881.8)
ATI 2500*	2500A	1899 (74.8)	1005 (39.6)	1007 (39.6)	400 (881.8)
ATI 3200*	3200A	1899 (74.8)	1005 (39.6)	1007 (39.6)	400 (881.8)

\*Floor standing.

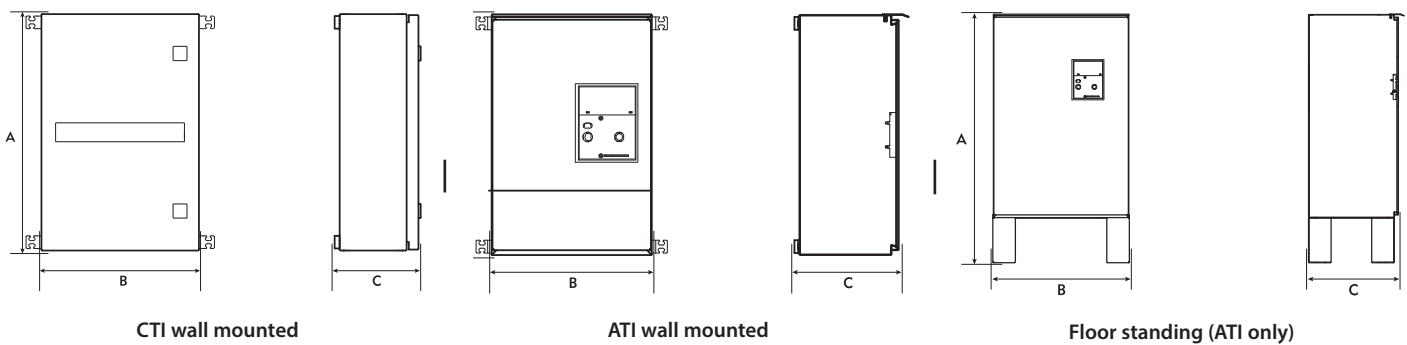

# CTI Panel Features

## CTI Load Transfer Panel – Ratings 63 – 160 Amps

Key: ○ – Standard Feature □ – Optional Feature

**Programmable Countdown Timers**  
Set routine times for delay on starts, delay on transfer, delay on re-transfer and run on timer.



**Auto/Manual/Test Mode Status Indication**  
Allows on/off load tests at routine service checks.



**Solid Neutral Kit**  
Allows the connection of neutral cables from utility power, generator set and load without having the neutral broken by the switch during transfer operations.



**LCD Display**  
Shows detailed status of system at all times for greater awareness and control.



**System Status Indicators**  
Shows status of utility power, generator set and switch at all times.

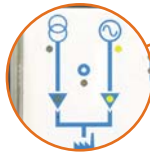

**Voltage Sensing Tap**  
Allows for pole voltage sensing.



**Wall Mounting Kit**  
Panel can be wall mounted for greater flexibility in positioning.



**Terminal shroud**  
For added protection.



**Keypad**  
For straightforward programming and testing. Password protection is included.



**Padlockable**  
Switch can be padlocked in all three positions for added security and safety. Only possible in manual operation mode.



**Manual Handle**  
Fully integrated handle for manual operation.



**Auxiliary Contacts**  
Auxiliary/volt free contacts for remotely monitoring the switch position.



**Control Terminals**  
Generator set remote start signal and terminals for remotely monitoring the system.

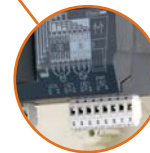

**Auxiliary Controls**  
Auxiliary inputs for automatic control, remote test on load and manual re-transfer.

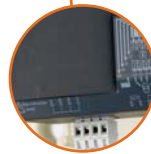

**Top and Bottom Cable Entry**  
Aids ease of installation



**Ingress Protection IP54**  
Protection for the control panel



**Load Terminal Extensions**  
Improving ease of installation



**Lightning Protection**  
Ensuring system safety



# ATI Panel Features

## ATI Load Transfer Panel – Ratings 250 – 1600 Amps

Key: ○ – Standard Feature □ – Optional Feature

### RS485 Communications Module

Enables access to the system remotely through telephone or PC via modem.

### Volt Free Contacts

For power available and generator available.

### System Status Indication

Shows status of utility power, generator set and switch at all times.

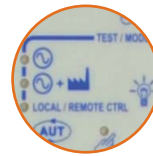

### Auto/Manual/ Test Mode Status Indication

Allows on/off load tests at routine service checks.

### Two Wire Start Signal

Simple two wire connection for automatic control.



### LCD Display

Shows detailed status of system at all times for greater awareness and control.

### Manual Handle

Fully integrated handle for manual operation.



### Power Metering

To measure load current, kW, kVAR, kVA, power factor.

### Padlockable

Switch can be padlocked in all three positions for added security and safety.

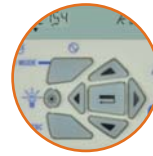

### Keypad

For straightforward programming and testing. Password protection is included.

### Solid Neutral

Allows the connection of neutral cables from utility power, generator set and load without having the neutral broken by the switch during transfer operations.



### Programmable Countdown Timers

Set routine times for delay on starts, delay on transfer, delay on re-transfer and run on timer.

### Wall Mounting Kit

Panel can be wall mounted for greater flexibility in positioning (ATI 250 and 400).



### Lightning Protection

Ensures the safety of system during lightning storms (includes volt free contacts for utility power and generator set).

### Bottom Gland Plate

Removable gland plate providing increased accessibility with a sizeable area for utility power and generator set cables to be connected.

### Auxiliary Contacts

Auxiliary / volt free contacts for remotely monitoring system; switch position, padlock and automatic or manual operation.

### Installation

Typical installation set up

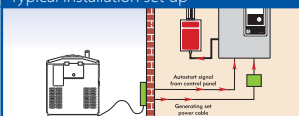

### Wall Mounting Panels

Wall mount with ease – includes fittings



### Ingress Protection IP54

Protection for the control panel



### Top Cable Entry

Aids eased installation



# ATI Panel Features

## ATI Load Transfer Panel – Ratings 2000 – 3200 Amps

Key: ○ – Standard Feature      □ – Optional Feature

### RS485 Communications Module

Enables access to the system remotely through telephone or PC via modem.



### Volt Free Contacts

For power available and generator available.

### System Status Indication

Shows status of utility power, generator set and switch at all times.



### Two Wire Start Signal

Simple two wire connection for automatic control.



### Manual Handle

Fully integrated handle for manual operation.



### Padlockable

Switch can be padlocked in all three positions for added security and safety.



### Auto/Manual/ Test Mode Status Indication

Allows on/off load tests at routine service checks.



### LCD Display

Shows detailed status of system at all times for greater awareness and control.



### Keypad

For straightforward programming and testing. Password protection is included.



### Programmable Countdown Timers

Set routine times for delay on starts, delay on transfer, delay on re-transfer and run on timer.



### Lightning Protection

Ensures the safety of system during lightning storms (includes volt free contacts for utility power and generator set).



### Bottom Gland Plate

Removable gland plate providing increased accessibility with a sizeable area for utility power and generator set cables to be connected.



### Auxiliary Contacts

Auxiliary / volt free contacts for remotely monitoring system; switch position, padlock and automatic or manual operation.



### Installation

Typical installation set up

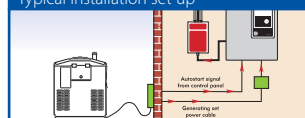

### Ingress Protection IP54

Protection for the control panel



# Features and Options

	1002T	DCP-10	DCP-20	PW 1.1	PW 1.1+	PW 2.1	easYgen 2500	easYgen 3200 <sup>+</sup>
<b>Instrumentation</b>								
LCD Display with Auto Power ff	-	-	-	●	●	●	●	●
Battery Trickle Charge Ammeter	-	-	-	○	○	○	○	○
Audible Alarm	-	●	●	○	○	○	○	○
Remote Annunciator	-	-	-	-	-	○	○	○
AC Metering	Voltmeter 3-phase ( L - L & L - N )	●	●	●	●	●	●	●
	Amps (per phase and average)	●	●	●	●	●	●	●
	Frequency	●	●	●	●	●	●	●
	kW (total & per phase)	-	-	●	-	-	●	●
	kVA (total & per phase)	-	-	●	-	-	●	●
	kVAr (total & per phase)	-	-	●	-	-	●	●
	Power Factor (overall and per phase)	-	-	●	-	-	●	●
	kW Hours	-	-	●	-	-	●	●
	kVAr Hours	-	-	●	-	-	●	●
	Battery Voltmeter	-	●	●	●	●	●	●
DC Metering	Engine Hours Run	●	●	●	●	●	●	●
	Engine Jacket Water Temperature (in °C or °F)	-	●	●	●	●	●	●
	Lube Oil Pressure (in Psi, kPA or bar)	-	●	●	●	●	●	●
	Engine Speed (rpm)	-	-	●	●	●	●	●
	Crank Attempt Counter	-	-	-	-	●	●	●
	Start Counter	-	-	-	-	●	●	●
<b>Protection</b>								
Fail to Start	-	●	●	●	●	●	●	●
Low Oil Pressure	●	●	●	●	●	●	●	●
High Engine Temperature	●	●	●	●	●	●	●	●
Underspeed, Overspeed	-	●	●	●	●	●	●	●
Loss of Engine Speed Detection	-	-	-	●	●	●	●	●
Low / High Battery Voltage	-	●	●	●	●	●	●	●
Battery Charger Failure (if Battery Charger fitted)	-	-	-	●	●	●	●	●
Under Volts, Over Volts	-	●	●	●	-	●	●	●
Under Frequency, Over Frequency	-	-	-	●	-	●	●	●
Overcurrent	-	-	-	-	-	●	●	●
Configurable Sender Input (for 'Oil Temperature' or 'Fuel Level' options only)	-	-	-	●	-	●	●	●
Earth Leakage Protection	-	-	-	○	○	○	○	○
Earth Fault Protection	-	-	-	○	○	○	○	○
Low Fuel Level Alarm	-	○	○	○	○	○	○	○
Low Fuel Level Shutdown	-	-	-	○	○	○	○	○
High Fuel Level Alarm	-	-	-	○	○	○	○	○
Fuel Transfer System Control	-	○	○	-	○	○	○	○
Low Coolant Level Shutdown	-	-	-	○	○	○	○	○
Low Coolant Temperature Alarm	-	●	●	●	●	●	○	○
High Lube Oil Temperature Shutdown	-	-	-	○	○	○	○	○
Overload via Alarm Switch on Breaker	-	-	-	○	○	○	-	○
Overload via Over Current Relay	-	-	-	○	○	-	-	○
Low Gas Pressure	-	-	-	-	-	-	-	○
High Gas Pressure	-	-	-	-	-	-	-	○
High Exhaust Temperature Alarm	-	-	-	●	●	●	○	○

	1002T	DCP-10	DCP-20	PW 1.1	PW 1.1+	PW 2.1	easYgen 2500	easYgen 3200 <sup>+</sup>
<b>Protection Monitoring</b>								
Name of Each Event	-	-	-	●	●	●	●	●
Engine Hours at First Occurrence of Event	-	-	-	●	●	●	●	●
Time and Date of First Occurrence of Event	-	-	-	-	-	●	●	●
Engine Hours at Last Occurrence of Event	-	-	-	●	●	●	●	●
Number of Occurrences of Event	-	-	-	●	●	●	●	●
<b>Instrumentation</b>								
Spare Fault Channels								
Number of Channels Available	0	0	4	3	5	5	5	6
Exceptions:								
On models P730P1 – P1100E1	-	-	-	-	3	3	4	5
On models P1250 – P2500-1	-	-	-	-	2	2	3	4
<b>Controls</b>								
2 LED Status Indicators (1 red shutdown, 1 amber warning)	-	-	●	●	●	●	●	●
Run key, Auto Key and Stop Key with LED indicators	-	●	●	●	●	●	●	●
Lamp Test	●	●	●	●	●	●	●	●
Alarm Acknowledge Key	-	●	●	●	●	●	●	●
Menu Navigation Keys	-	●	●	●	●	●	●	●
Dedicated Key to reset all events	-	-	-	●	●	●	-	-
Engine and AC Metering Short Cut Keys	-	-	-	●	●	●	-	-
Main Menu and Event Log Short Cut Keys	-	-	-	●	●	●	●	●
Control Module Keys with Tactile Feedback	-	-	-	●	●	●	●	●
CAN 1 Data Link - J1939 for communicating with electronic engine control modules	-	-	-	●	●	●	●	●
CAN 2 Accessory Data Link - for additional modules remote annunciator, digital input/output module	-	-	-	-	-	●	●	●
Remote Monitoring and Control Data Link (ModBus)	-	-	-	-	-	●	●	●
Real Time Clock	-	-	-	-	-	●	●	●
Service Maintenance Interval Warning	-	-	-	-	-	●	●	●
Remote Monitoring and Control	-	-	-	-	-	○	○	○
Static Battery Charger	-	-	-	○	○	○	●	●
Static Battery Charger with Auto Boost	-	○	○	○	○	○	○	○
Volt Free contacts for: Common Alarm & Generator Set Running	-	○	○	○	○	○	○	○
Engine Coolant Heater Controls	-	-	-	○	○	○	○	○
Control Panel Heater	-	-	-	-	○	○	-	○
Volts Adjust Potentiometer	-	-	-	○	○	○	●	●
Speed Adjust Potentiometer	-	-	-	○	○	○	●	●
Speed Adjust Switch	-	-	-	○	○	○	○	○
Oil Temperature Display	-	-	-	-	○	○	○	○
Oil Temperature Gauge	-	-	-	○	○	○	-	-
Lube Oil Temperature displayed on LCD screen	-	-	-	○	○	○	○	○
Fuel Level Switch	-	○	-	○	-	-	○	○
Fuel Level Sender & Display	-	-	○	-	○	○	○	○
Panel Lockdown Stop Push Button with security key	-	-	-	○	○	○	-	-
Netbiter Internet Monitoring and Control Unit	-	-	-	-	-	-	○	○
Mains Load Sensing Unit	-	-	-	-	-	-	-	○
Additional 8 inputs and 8 outputs	-	-	-	-	-	-	-	○

Key: ● – Standard; ○ – Optional

**Panel Display languages**

Arabic\*, Bulgarian\*, Chinese, Czech\*, Danish\*, Dutch\*, English, Estonian\*, Finnish\*, French, German, Greek\*, Hungarian\*, Icelandic\*, Italian, Japanese, Latvian\*, Lithuanian\*, Norwegian\*, Polish, Portuguese, Romanian\*, Russian, Slovak\*, Slovene\*, Spanish, Swedish\*, Turkish.

\* Not available for easYgen control panels. + Available through Power Solutions.



# Features and Options

	CTI	ATI < 1600A	ATI > 2000A
<b>Motorised Mechanically Held Switch</b>			
Facility for manual changeover	●	●	●
<b>Protection</b>			
Utility power available	●	●	●
Utility power on load	●	●	●
Generator available / Generator on load	●	●	●
Utility power and generator off load	●	●	●
Manual mode / Automatic mode	●	●	●
Test on load / Test off load	●	●	●
Manual re-transfer for enabled / required	●	●	●
Power / Error indication (LED)	●	●	●
<b>Facia</b>			
Universal symbols to allow for multiple languages	●	●	●
<b>Liquid Crystal Display</b>			
Utility Power L1-2, L1-3, L2-3 voltage	●	●	●
Utility Power L1-N, L2-N, L3-N voltage	●	●	●
Generator Set L1-N, L2-N, L3-N voltage	●	●	●
Generator Set L1-2, L1-3, L2-3 voltage	●	●	●
Utility Power Frequency / Generator Set Frequency	●	●	●
Number of times switch transfers from mains to generator set	●	●	●
Timer settings	●	●	●
<b>Standards</b>			
Complete enclosure meets standard IEC 60947-6-1	●	●	●
Switch meets standard AC31B	●	●	●
<b>Controls</b>			
Under / Over frequency failure	●	●	●
Under / Over frequency restoration	●	●	●
Manual / Auto re-transfer	●	●	●
Mode select push button	●	●	●
Under / Over Volts Failure	●	●	●
Under / Over Volts Restoration	●	●	●
Delay on Start Timer	●	●	●
Delay on Transfer	●	●	●
Delay on Re-Transfer	●	●	●
Dead Band Timer	●	●	●
Run On Timer	●	●	●
Auto / Manual Control Keyswitch	●	●	●
Lamp Test Pushbutton	●	●	●
Padlock facility	●	●	●
Selection between Contactor or Switch Mode	●	-	-
<b>Cable entry</b>			
Top	●	-	-
Bottom	●	●	●
<b>Load Terminal Extensions</b>			
Improving ease of installation	○	-	-



	CTI	ATI < 1600A	ATI > 2000A
<b>Auxiliary Contacts</b>			
For monitoring of switch position (Including padlocking & auto / manual)	-	●	●
<b>Lightning Protection</b>			
Ensuring the safety of system during lightning storms	○	○	○
<b>Ingress Protection IP54</b>			
Protection for control module	○	○	●
<b>Power Metering</b>			
To measure load current, kW, kVA, Power factor	-	●	-
<b>Volt Free Cotacts</b>			
For utility power availability & generator available	●	○	○
<b>Communication Module</b>			
Plug in module that uses Jbus/modbus protocol to allow remote communication of the change over system	-	○	○
<b>Voltage Sensing Tap</b>			
Allowing for pole voltage sensing	○	-	-
<b>Solid Neutral Kit</b>			
To connect neutral cables from the mains, generator set and load	○	○	-
<b>Terminal Shroud</b>			
For added protection	○	-	-

**Key:** ● – Standard; ○ – Optional

Note: Options available depends on the exact configuration of the generator set package. Not all options are available on all packages. Please contact your local FG Wilson Dealer for more information

**FG Wilson manufactures product in the following locations:**

Northern Ireland • Brazil • China • India • USA

With headquarters in Northern Ireland, FG Wilson operates through a Global Dealer Network. To contact your local Sales Office please visit the FG Wilson website at [www.FGWilson.com](http://www.FGWilson.com).

FG Wilson is a trading name of Caterpillar (NI) Limited.

In line with our policy of continuous product development, we reserve the right to change specification without notice.