



**HENNLICH**

*Accumulators & Cooling*



# Niederdruckpumpen HCMP-SSP

Low Pressure Pumps  
HCMP-SSP



## Anwendung

### INDUSTRIE

Schmierölanwendungen, Hydraulikanwendungen (z.B. Pressen, Werkzeugmaschinen ...), in großen Antriebsstationen und kleinen Einheiten Filter-, Heiz – Kühler Umwälzkreise zur Öl-Aufbereitung, Prozeß- und Chemieindustrie ...

*lube services, power hydraulics (presses, machinetools ...), powerunits & minipower, cooling, heating, recycling process- and chemistry technology ...*



### POWER GENERATION

Schmieröl-Versorgung, Steueröl-Versorgung, Kraftstoff-Versorgung  
Filtration & Kühlung ...

*lube oil service, control oil service, fuel unloadingstation, fuel transfer, filtration&cooling ...*



### MARINE

Nebenstromfiltration, Filtration & Öltransfer, Kraftstoff-Service,  
Schmierölkreislauf-Service...

*off-line filtration, filtration & oil transfer, fuel service, lube oil circulation service...*



### ÖL & GAS

Ölfiltration & Kühlung, Öl- und Kraftstoffölschmierung, Ölplattformen,  
Raffinerien, Petrochemische Industrie ...

*oilfiltration&cooling, oil and fuel oil, lubrication oil rigs, refineries (transport, meter and mix), off-shore platform, Petrochemical industry...*



# Typenschlüssel

HCMP - SSP - 60 - 4D - 2,2 - RF2 - Z

<b>HENNLICH Niederdruckpumpen</b>	
<b>HENNLICH Low Pressure Pumps</b>	
<b>Neendurchfluss / Nominal Flow [L/min] (50 Hz)</b>	
13	
20	
30	
40	
60	
80	
<b>Polzahl / Pole Number</b>	
4	4-polig (1500 1/min)
(6)*	6-polig (1000 1/min)
(8)*	8-polig (750 1/min)
<b>Motorspannung / Motor Voltage [V]</b>	
A	3-fasig 230/400 V, 50 Hz
B	3-fasig 275/480 V, 60 Hz
C	1-fasig 230 V, 50/60 Hz
D	230/400 V, 50 Hz, 460 V, 60 Hz
E	3-fasig 500 V, 50 Hz
F	3-fasig 400/690 V, 50 Hz
G	Sonderspannung
<b>Motorleistung / Motor Performance [kW] (50 Hz)</b>	
0,37	
0,55	
0,75	
1,1	
1,5	
2,2	
3	
4	
<b>Bypassventil / Bypass Valve</b>	
RF1	5 bar
RF2	10 bar
RF3	15 bar
<b>Sonderausführung, Special Construction</b>	
Details i. Klartext, z.B. lackiert RAL... /	

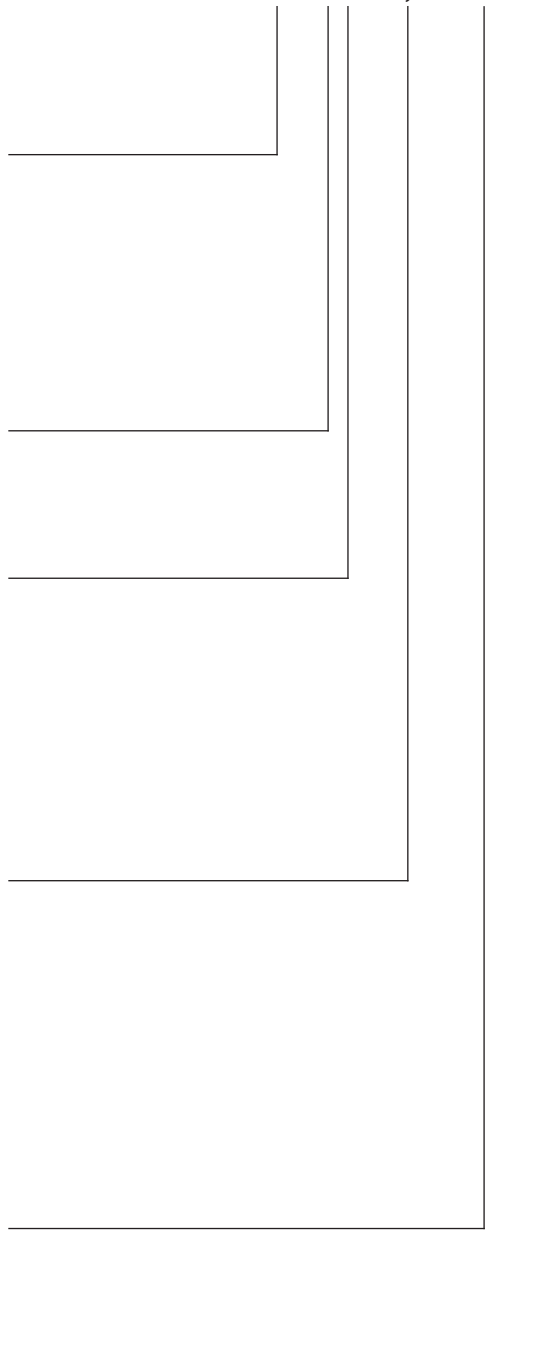

\*auf Anfrage



## Technische Eigenschaften

verfügbare Modelle / <i>available models</i>	GR32 - GR40 - GR45
Flansche / <i>flanges</i>	IEC standard (für direkte Kupplung mit dem Motor), Größe B5 / <i>IEC standard (for direct coupling with motor), size B5</i>
Anschlüsse / <i>connections</i>	ISO 228-1
Drehrichtung / <i>shaft rotation</i>	Rechtslauf (Blick auf Wellenende) / <i>clockwise (from shaft end)</i>
Nenn Drehzahl / <i>nominal speed</i>	500 - 1.750 rpm
Nenn durchfluss / <i>flow rate</i>	13 - 80 l/min (bei/ at 1.450 rpm)
max. Betriebsdruck Pumpe / <i>max. operation pressure pump</i>	15 bar
Eingangsdruck / <i>inlet pressure</i>	(je nach Motorleistung weniger / depending on engine power also less)
min. -0,2 bar max. 1,5 bar	
Viskosität / <i>viscosity</i>	10 - 1.000 cSt*
Dichtungen / <i>seals</i>	NBR, (FKM, EPDM)
Schalldruckpegel / <i>noise level</i>	55 - 63 dB(A) (bei/ at 1.750 rpm)
Material Gehäuse (Spezial Anwendung) / <i>pump body (special application)</i>	Aluminium Standard (Gusseisen/ cast iron)
Umgebungstemperatur / <i>ambient temperature</i>	-20 °C - +40 °C (andere auf Anfrage/ others on request)
Temperatur Medium / <i>medium temperature</i>	-20 °C - +100 °C
Filtrierung / <i>filtration</i>	Reinheitsklasse nach NAS 1638 Klasse 8 oder ISO DIS 4406 17/14. Empfohlene Filtration $\beta_{25} \geq 75$ / <i>permissible degree of fluid contamination to NAS 1638 class 8 or ISO DIS 4406 17/14. Recommended filtration <math>\beta_{25} \geq 75</math></i>

\*in Abstimmung mit Ihrem HENNLICH Partner

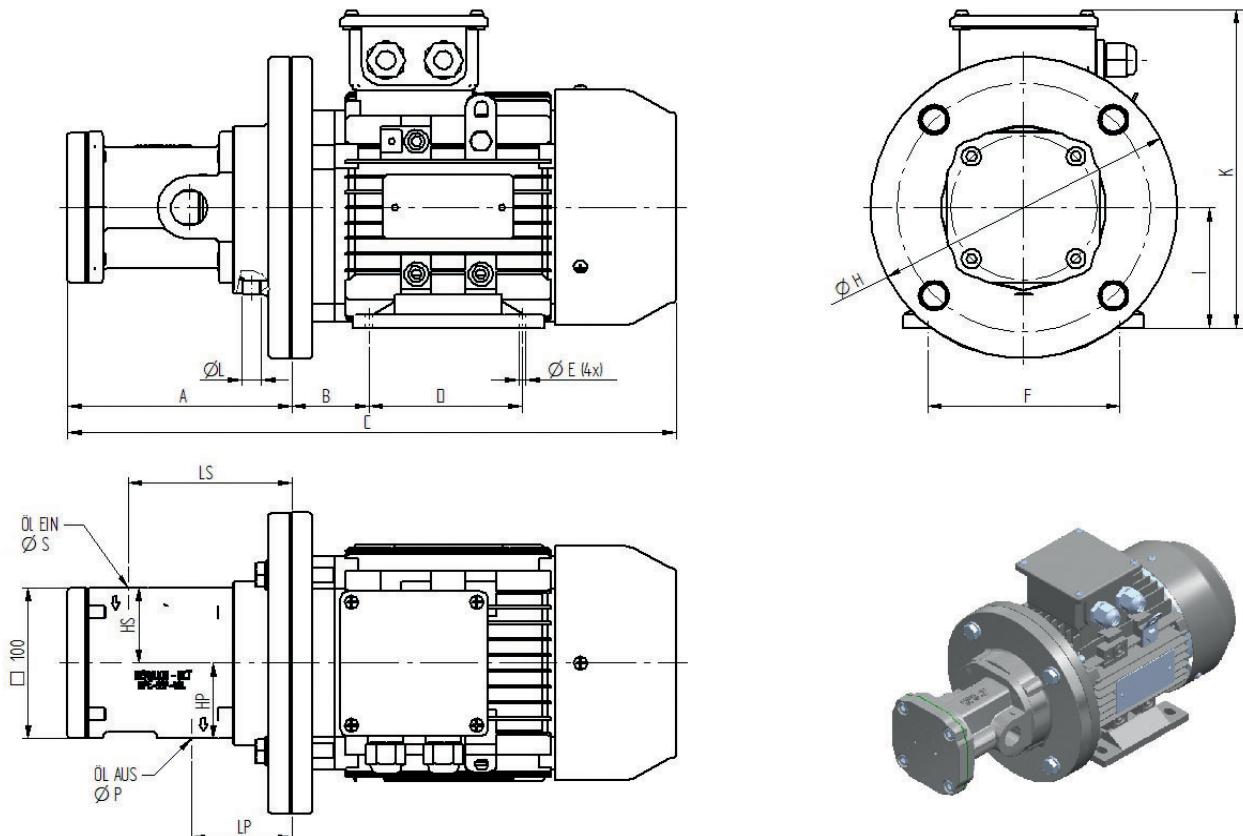

Typ / type	MOTOR - BG	Polzahl / pole number	Motorleistung / engine performance kW	Nennvolumenstrom / nominal oil flow [L/min]	Gewicht* /weight* ca [kg]	Abmessungen / dimension [mm]									
						A	B	C*	D	E	F	I	K*	LS	LP
HCMP-SSP-13	71	4	0,37	13	9,2	131	45	215	90	7	112	71	185	93	52
HCMP-SSP-13	80	4	0,55	13	15,8	145	50	250	100	10	125	80	295	107	66
<b>HCMP-SSP-20</b>	<b>80</b>	<b>4</b>	<b>0,75</b>	<b>20</b>	<b>15,8</b>	<b>145</b>	<b>50</b>	<b>250</b>	<b>100</b>	<b>10</b>	<b>125</b>	<b>80</b>	<b>295</b>	<b>107</b>	<b>66</b>
HCMP-SSP-20	90	4	1,1	20	20,5	153	56	275	100	10	140	90	330	115	74
HCMP-SSP-20	90	4	1,5	20	23,4	153	56	300	125	10	140	90	355	115	74
<b>HCMP-SSP-30</b>	<b>80</b>	<b>4</b>	<b>0,75</b>	<b>30</b>	<b>15,7</b>	<b>146</b>	<b>50</b>	<b>250</b>	<b>100</b>	<b>10</b>	<b>125</b>	<b>80</b>	<b>295</b>	<b>108</b>	<b>67</b>
HCMP-SSP-30	90	4	1,1	30	19,8	154	56	275	100	10	140	90	330	116	75
HCMP-SSP-30	90	4	1,5	30	22,7	154	56	300	125	10	140	90	355	116	75
HCMP-SSP-30	100	4	2,2	30	29	162,3	63	338	140	12	160	100	405	124	83
<b>HCMP-SSP-40</b>	<b>80</b>	<b>4</b>	<b>0,75</b>	<b>40</b>	<b>15,7</b>	<b>146</b>	<b>50</b>	<b>250</b>	<b>100</b>	<b>10</b>	<b>125</b>	<b>80</b>	<b>295</b>	<b>108</b>	<b>67</b>
<b>HCMP-SSP-40</b>	<b>90</b>	<b>4</b>	<b>1,1</b>	<b>40</b>	<b>19,8</b>	<b>154</b>	<b>56</b>	<b>275</b>	<b>100</b>	<b>10</b>	<b>140</b>	<b>90</b>	<b>330</b>	<b>116</b>	<b>75</b>
<b>HCMP-SSP-40</b>	<b>90</b>	<b>4</b>	<b>1,5</b>	<b>40</b>	<b>22,7</b>	<b>154</b>	<b>56</b>	<b>300</b>	<b>125</b>	<b>10</b>	<b>140</b>	<b>90</b>	<b>355</b>	<b>116</b>	<b>75</b>
HCMP-SSP-40	100	4	2,2	40	29	162	63	338	140	12	160	100	405	124	83
HCMP-SSP-40	100	4	3	40	29	162	63	338	140	12	160	100	405	124	83
<b>HCMP-SSP-60</b>	<b>90</b>	<b>4</b>	<b>1,5</b>	<b>60</b>	<b>24</b>	<b>188</b>	<b>56</b>	<b>300</b>	<b>125</b>	<b>10</b>	<b>140</b>	<b>90</b>	<b>355</b>	<b>137</b>	<b>81</b>
HCMP-SSP-60	100	4	2,2	60	30	201	63	338	140	12	160	100	405	150	94
HCMP-SSP-60	100	4	3	60	35,8	201	63	338	140	12	160	100	405	150	94
HCMP-SSP-80	90	4	1,5	80	24	188	56	300	125	10	140	90	355	137	81
<b>HCMP-SSP-80</b>	<b>100</b>	<b>4</b>	<b>2,2</b>	<b>80</b>	<b>30</b>	<b>201</b>	<b>63</b>	<b>338</b>	<b>140</b>	<b>12</b>	<b>160</b>	<b>100</b>	<b>405</b>	<b>150</b>	<b>94</b>
<b>HCMP-SSP-80</b>	<b>100</b>	<b>4</b>	<b>4-3</b>	<b>80</b>	<b>35,8</b>	<b>201</b>	<b>63</b>	<b>338</b>	<b>140</b>	<b>12</b>	<b>160</b>	<b>100</b>	<b>405</b>	<b>150</b>	<b>94</b>
HCMP-SSP-80	112	4	4-4	80	43,7	201	70	387	140	12	190	112	450	150	94

fett hervorgehoben: Vorzugstypen

## ANSCHLÜSSE / CONNECTIONS

Reihe / line	Größe / size	S (ISO 228)	HS	P (ISO 228)	HP	L (ISO 228)	Schalldruckpegel / sound pressure level dB(A) 1m**
HCMP-SSP 13 + 20	GR 32	1"	50	3/4"	50	1/4"	63
HCMP-SSP 30 + 40	GR 40	1"	50	3/4"	50	1/4"	64
HCMP-SSP 60 + 80	GR 45	1-1/2"	70	1-1/4"	65	1/4"	65

\* Variiert mit dem Motorfabrikat / varies with the engine brand

\*\* Geräuschpegeltoleranz +/- 3 dB(A) / noise tolerance +/- 3 dB(A)

Fertigungstoleranzen sind nicht berücksichtigt. Änderungen vorbehalten. / Manufacturing tolerances are not considered. Changes reserved.

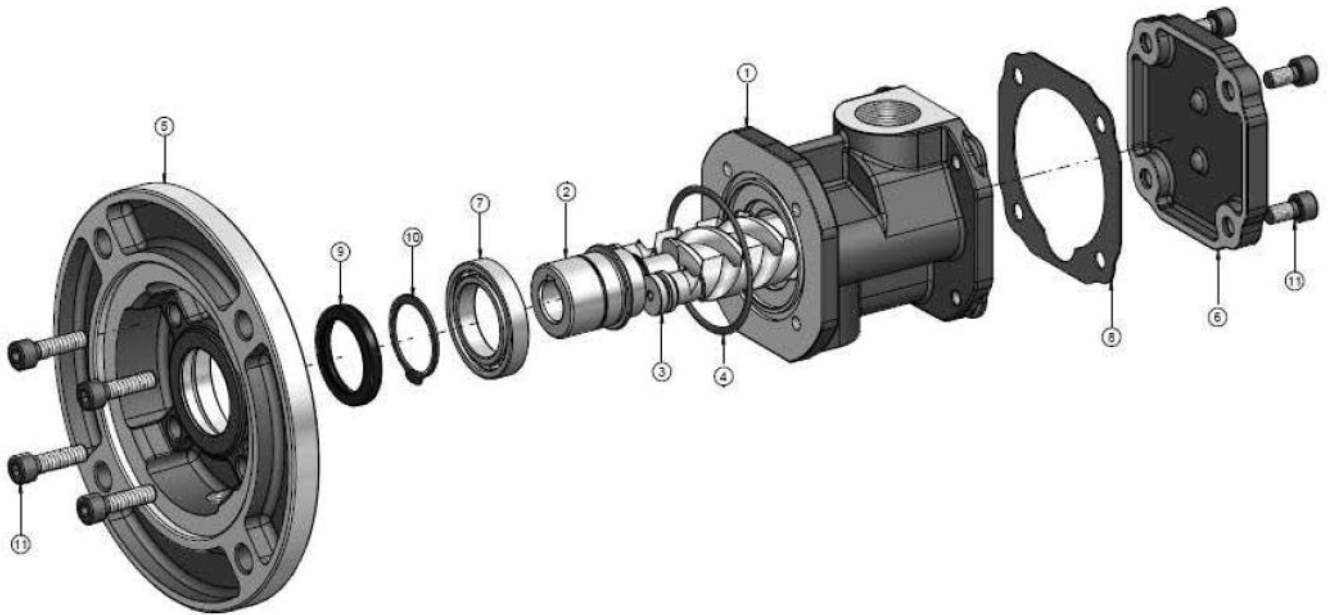

N°	Beschreibung / Description	Material / Material
1	Pumpenkörper/ pump body	Aluminium, Gusseisen/ aluminium, cast iron*
2	Hauptschraube/ main screw	Stahl/ steel*
3	Zwischenradschraube/ idler screw	Gusseisen/ cast iron*
4	o-ring	NBR/ FKM*
5	Vorderseite/ front cover	Aluminium*
6	Rückseite/ end cover	Aluminium*
7	Kugellager/ ball bearing	Stahl/ Steel*
8	Dichtung/ gasket	NBR*
9	Lippendichtung/ lip seal	NBR/ FKM*
10	Sicherungsring/ circlip	Stahl/ Steel*
11	Schrauben/ screws	Stahl/ Steel*

## HOHLWELLEN VERFÜGBARKEIT / HOLLOW SHAFT AVAILABILITY

Größe / size	Typ / type	AC14	AC19	AC24	AC28	AC38
GR 32	13L	x	x	x		
	17L					
	20L					
	25L					
GR 40	30L		x	x	x	
	40L					
GR 45	45L			x	x	x
	60L					
	80L					

# GR32 Leistung

## VOLUMENSTROM / FLOW

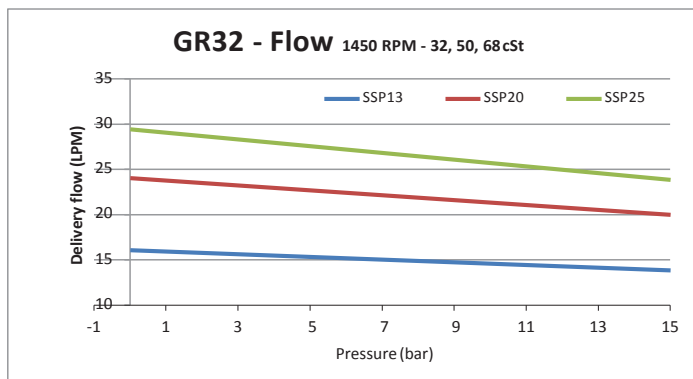

## LEISTUNG / POWER

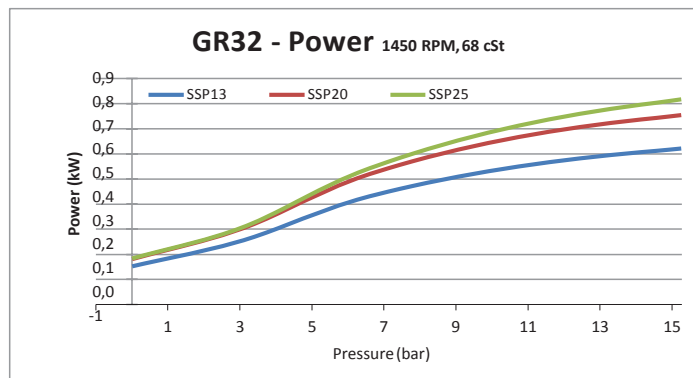
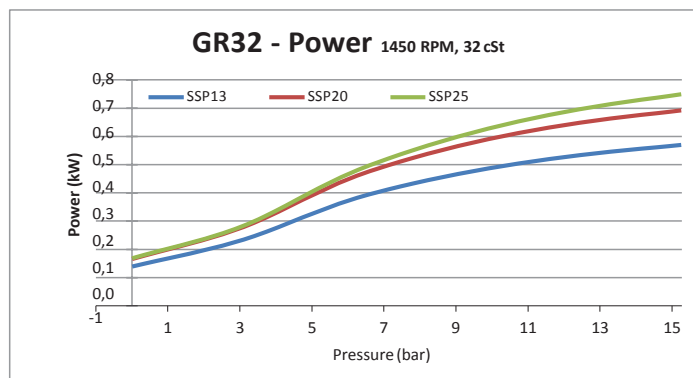
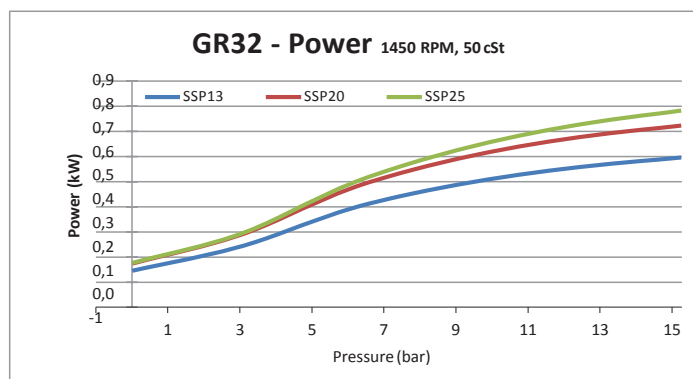



## GR40 Leistung

### VOLUMENSTROM / FLOW

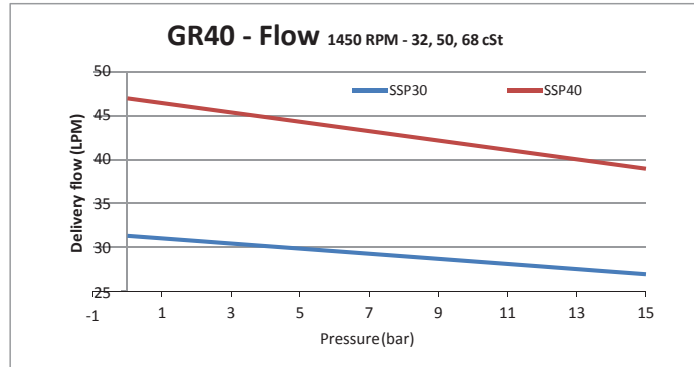

### LEISTUNG / POWER

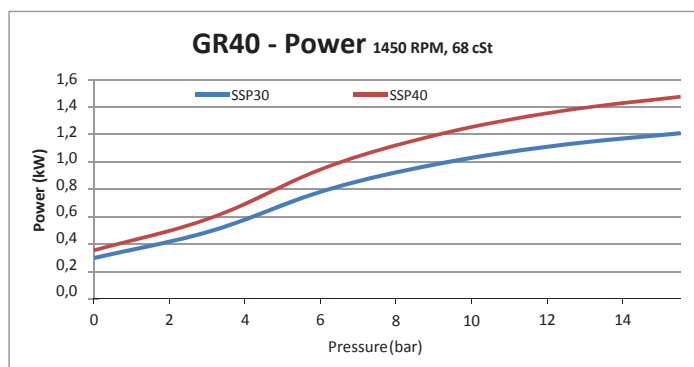
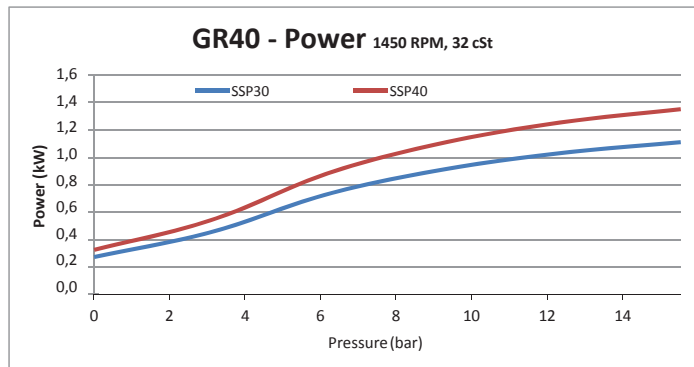
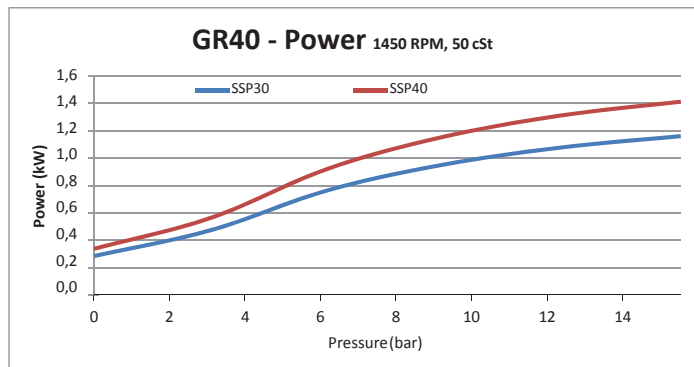



# GR45 Leistung

## VOLUMENSTROM / FLOW

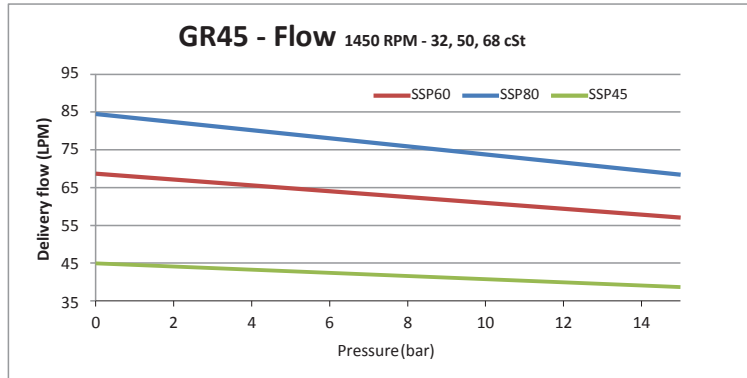

## LEISTUNG / POWER

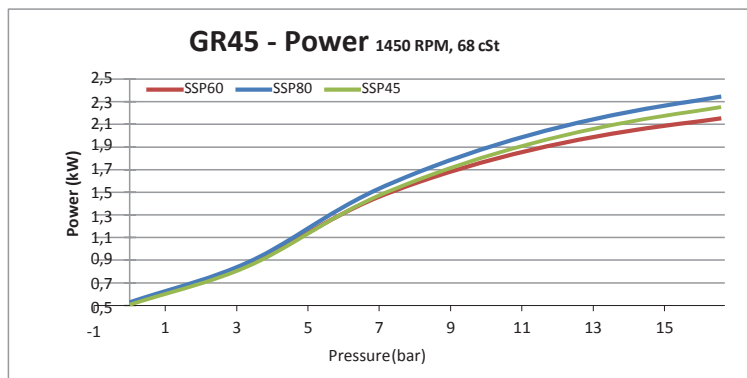
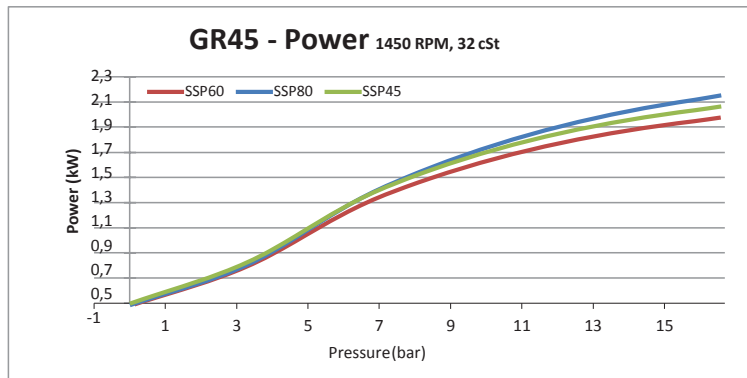
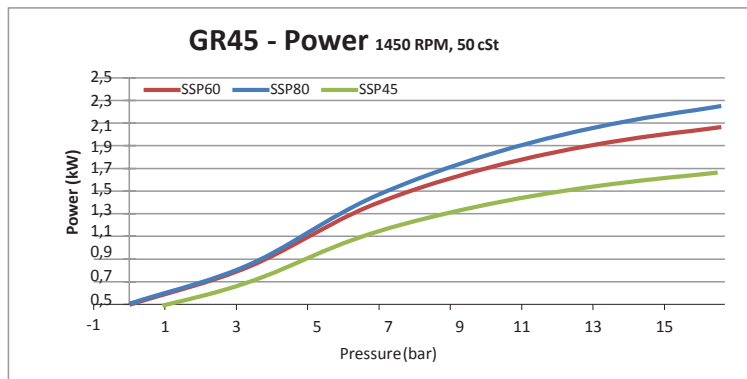



Deutschland:  
**HENNLICH - HCT GmbH**  
Im Gewerbegebiet 8  
DE-66386 St Ingbert  
Tel. +49 6894 95558 - 0  
office@hennlich-hct.de  
www.hennlich-hct.de

Österreich:  
**HENNLICH**  
**Cooling - Technologies GmbH**  
Schnelldorf 51  
A-4975 Suben  
Tel. +43 7711 / 33066 - 0  
cooling@hennlich.at  
www.hennlich.at

Schweiz:  
**HENNLICH (Schweiz) GmbH**  
Bonnstraße 28  
CH-3186 Düringen  
Tel. +41 26 505 14 60  
office@hennlich.ch  
www.hennlich.ch