

SLPCR25-690

Personnel Safety, Light Screen – Receiver Cascadable

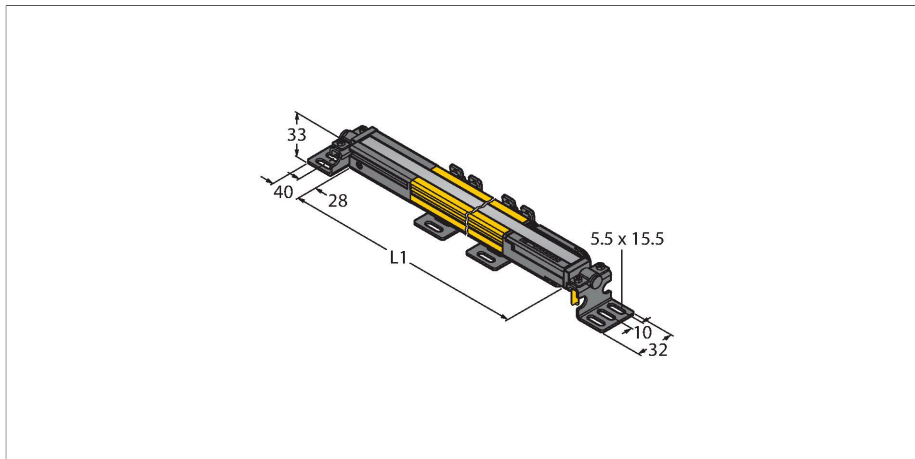

Technical data

Type	SLPCR25-690
ID	3083715
Optical data	
Function	Light screen
Optical resolution	25 mm
Range	100...7000 mm
Scan field	690 mm
Number of beams	35
With muting function	no
Scan Code	Adjustable
Electrical data	
Operating voltage	20...28 VDC
Residual ripple	< 10 % U _{ss}
DC rated operational current	≤ 150 mA
Current consumption non-actuated	≤ 150 mA
No-load current	≤ 275 mA
Max. current safe output	500 mA
Short-circuit protection	yes
Reverse polarity protection	yes
Output function	2 x NC (normally closed), 2 x PNP
Current output	0...500 mA
Number of safe semiconductor outputs	2
Response time typical	< 12.5 ms
With restart interlock	yes
Blanking function	yes

Features

- Electrical connection via RDLP-8 with open end or via DELPE-8 with male M12 × 1, 8-pin
- Connection to cascadable nodes via DELP-1...
- Protection class IP65
- Flat housing without blind zone
- Adjustment via DIP switch
- Resolution can be reduced
- Blanking function
- Operating voltage: 24 VDC ± 15 %
- Resolution 25 mm
- Scan field 690 mm (L1)
- Personnel safety Cat 4, PL e acc. to EN ISO 13849-1:2008
- Type 4 according to IEC 61496-1,-2
- SIL 3 to IEC 61508

Wiring diagram

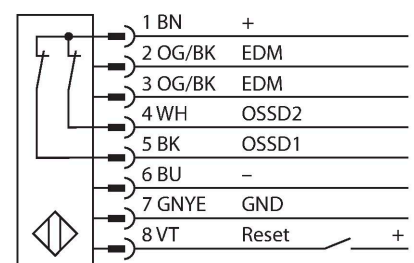

Functional principle

The high-resolution safety light curtain is emitter and receiver in one without blind zone. As the system is synchronized optically, wiring between emitter and receiver is redundant. The safety switching outputs of the receiver are directly connected to a load relay (e.g.

Technical data

Mechanical data	
Design	Rectangular, EZ-Screen LP
Dimensions	26 x 28 x 689 mm
Housing material	Metal, AL, Yellow polyester
Lens	plastic, Acrylic
Cascadable	Yes
Electrical connection	Cable entry for flat connector
Ambient temperature	0...+55 °C
Protection class	IP65
Power-on indication	LED, Green
Switching state	2-color LED, Red
Tests/approvals	
Vibration resistance	10-55 Hz at 0.35 mm
Shock test	10 g at 16 ms (6000 cycles)
Approvals	CE, cTUVus, PL e acc. to ENISO 13849-1:2008, SIL 3 acc. to IEC 61508

IM-TA9A) and trigger an immediate stop of the dangerous machine cycle. The switching device with 2-channel monitoring, diverse redundant designed and mutual processor control, complies with the personnel safety category PLe acc. to ISO 13849-1.

Accessories

LPA-MBK-11	3082841	LPA-MBK-12	3082842
	Mounting bracket, retainer for closure caps, 14-ga. steel, galvanized, black, 360 ° sensor rotation, incl.2 pcs. with screw set		Mounting bracket, side mounting, 14-ga. steel, galvanized, black, +10°/-30° sensor rotation, incl.1 pcs. with screw set
LPA-MBK-20	3082853	LPA-MBK-22	3082844
	Mounting bracket, wall mounting, 12-ga. steel, galvanized, black, in combination with LPA-MBK-11/ -12/ -13, incl. 1 pcs. and screw set		Mounting bracket, wall mounting, 14-ga. steel, galvanized, black, in combination with LPA-MBK-11, incl. 2 pcs. and screw set
LPA-MBK-21	3082845	LPA-MBK-90	3082846
	Mounting bracket, side mounting, 14-ga. steel, galvanized, black, +10°/-30° sensor rotation, for mounting of cascadable EZ-Screen LP, adjustable orientation 90° to 180 °		Mounting bracket, side mounting, 14-ga. steel, galvanized, black, +10°/-30° sensor rotation, for mounting of cascadable EZ-Screen LP, firm orientation 90 °
LPA-MBK-120	3082847	LPA-MBK-135	3082848
	Mounting bracket, side mounting, 14-ga. steel, galvanized, black, +10°/-30° sensor rotation, for mounting of cascadable EZ-Screen LP, firm orientation 120°		Mounting bracket, side mounting, 14-ga. steel, galvanized, black, +10°/-30° sensor rotation, for mounting of cascadable EZ-Screen LP, firm orientation 135 °
LPA-MBK-180	3082849		
	Mounting bracket, side mounting, 14-ga. steel, galvanized, black, +10°/-30° sensor rotation, for mounting of cascadable EZ-Screen LP, firm orientation 180 °		

Accessories

Dimension drawing	Type	ID	
	RDLP-815D	3080792	Connection cable, PVC, yellow, length: 4.57 m, RD connector for direct connection to the light screen
	RDLP-825D	3080793	Connection cable, PVC, yellow, length: 7.62 m, RD connector for direct connection to the light screen
	RDLP-850D	3080794	Connection cable, PVC, yellow, length: 15.2 m, RD connector for direct connection to the light screen
	RDLP-875D	3080795	Connection cable, PVC, yellow, length: 22.9 m, RD connector for direct connection to the light screen
	DELPE-81D	3080811	Connection cable, PVC, yellow, length: 0.31 m, RD connector for direct connection on male M12 x 1, 8-pin,
	DELPE-83D	3080812	Connection cable, PVC, yellow, length: 0.91 m, RD connector for direct connection on male M12 x 1, 8-pin,
	DELPE-88D	3080813	Connection cable, PVC, yellow, length: 2.44 m, RD connector for direct connection on male M12 x 1, 8-pin,
	DELPE-815D	3080814	Connection cable, PVC, yellow, length: 4.57 m, RD connector for direct connection on male M12 x 1, 8-pin,
	DELPE-825D	3080815	Connection cable, PVC, yellow, length: 7.62 m, RD connector for direct connection on male M12 x 1, 8-pin,
	DELPE-850D	3080816	Connection cable, PVC, yellow, length: 15.2 m, RD connector for direct connection on male M12 x 1, 8-pin,
	DELPE-875D	3080817	Connection cable, PVC, yellow, length: 22.9 m, RD connector for direct connection on male M12 x 1, 8-pin,
	DELPE-8100D	3080818	Connection cable, PVC, yellow, length: 30.5 m, RD connector for direct connection on male M12 x 1, 8-pin,
	DELP-110E	3080802	Connection cable, PVC, yellow, length: 0.05 m, RD connector on RD connector, for interconnection of cascable light screens of the EZ-Screen LP series
	DELP-111E	3080803	Connection cable, PVC, yellow, length: 0.3 m, RD connector on RD connector, for interconnection of cascable light screens of the EZ-Screen LP series
	DELP-113E	3080804	Connection cable, PVC, yellow, length: 0.91 m, RD connector on RD connector, for interconnection of cascable light screens of the EZ-Screen LP series
	DELP-118E	3080805	Connection cable, PVC, yellow, length: 2.44 m, RD connector on RD connector, for interconnection of cascable light screens of the EZ-Screen LP series
	DELP-1115E	3080806	Connection cable, PVC, yellow, length: 4.57 m, RD connector on RD connector, for interconnection of cascable light screens of the EZ-Screen LP series
	DELP-1125E	3080807	Connection cable, PVC, yellow, length: 7.62 m, RD connector on RD connector, for interconnection of cascable light screens of the EZ-Screen LP series
	DELP-1150E	3080808	Connection cable, PVC, yellow, length: 15.2 m, RD connector on RD connector, for interconnection of cascable light screens of the EZ-Screen LP series
	DELP-1175E	3080809	Connection cable, PVC, yellow, length: 22.9 m, RD connector on RD connector,

Dimension drawing	Type	ID	
			for interconnection of cascable light screens of the EZ-Screen LP series
	DELP-11100E	3080810	Connection cable, PVC, yellow, length: 30.5 m, RD connector on RD connector, for interconnection of cascable light screens of the EZ-Screen LP series
	CSB-M1280M1280	3075375	Y-piece, PVC, yellow, with male M12 x 1, 8-pin on 2 x 0.3 m cable, PVC, yellow, with female M12 x 1, 8-pin
	CSB-M1281M1281	3073252	Y-piece, PVC, yellow, length: 0.3 m with male, M12 x 1, 8-pin on 2 x 0.3 m cable, PVC, yellow, with female, M12 x 1, 8-pin
	CSB-M1288M1281	3073253	Y-piece, PVC, yellow, length: 2.5 m with male, M12 x 1, 8-pin on 2 x 0.3 m cable, PVC, yellow, with female, M12 x 1, 8-pin
	CSB-M12815M1281	3073254	Y-piece, PVC, yellow, length: 4.6 m with male, M12 x 1, 8-pin on 2 x 0.3 m cable, PVC, yellow, with female, M12 x 1, 8-pin
	CSB-M12825M1281	3073255	Y-piece, PVC, yellow, length: 7.6 m with male, M12 x 1, 8-pin on 2 x 0.3 m cable, PVC, yellow, with female, M12 x 1, 8-pin