

D08 Standard Flow Parallel Manifold

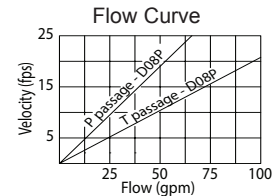
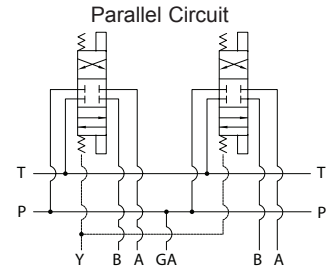
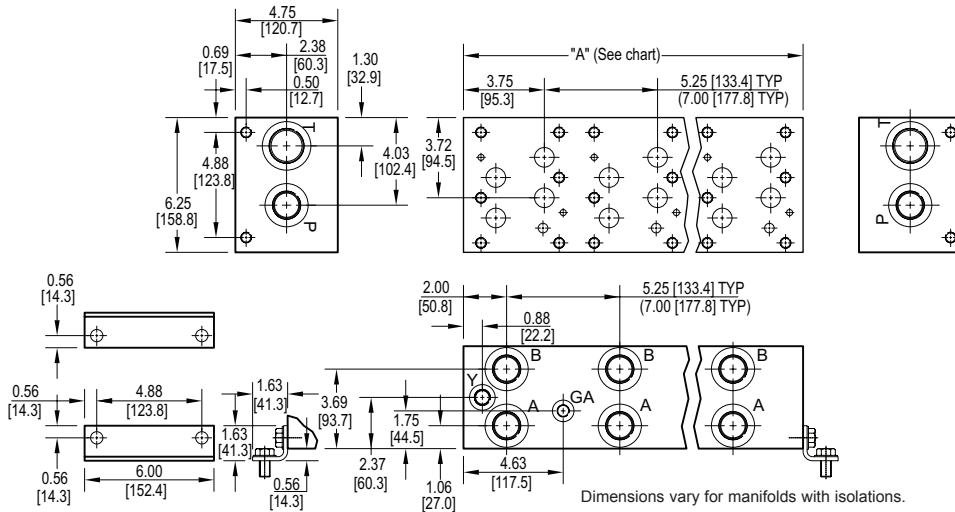

No. of stations	* 01	02	03	04	05	06	07	08
"A" length (code 5 spa.) inch [mm]	5.25 [133.4]	10.50 [266.7]	15.75 [400.1]	21.00 [533.4]	26.25 [666.8]	31.50 [800.1]	36.75 [933.5]	42.00 [1066.8]
apx. weight alum lb [kg]	12 [5]	24 [11]	35 [16]	49 [22]	61 [28]	75 [34]	89 [40]	102 [46]
apx. weight ferrous lb [kg]	45 [20]	90 [41]	136 [62]	181 [82]	226 [103]	271 [123]	316 [143]	362 [164]
"A" length (code 7 spa.) inch [mm]	--	12.25 [311.2]	19.25 [489.0]	26.25 [666.8]	33.25 [844.6]			
apx. weight alum lb [kg]	--	28 [13]	44 [20]	60 [27]	76 [34]			
apx. weight ferrous lb [kg]	--	105 [48]	166 [75]	226 [103]	286 [130]			

* Gauge port not available on 01 station.

All mounting hardware is supplied.
See page 65 for itemized list.

Port code	Valve mtg.	Manifold mtg.
P, S	0.50-13 UNC x 1.19 [30] DP	0.50-13 UNC x 0.88 [22.3] DP
B, M, T	M12 ISO 6H x 1.19 [30] DP	M12 ISO 6H x 0.88 [22.3] DP

Specifications, descriptions, and dimensional data are subject to correction or change without notice or incurring obligation.
Download latest catalog page revisions at www.daman.com.

Ordering Information

For **coating options**
see pages 245-246.

Material	Valve Pattern	Circuit	No. of Stations	Valve Spacing	Port Threads	Options																																																																																		
<table border="1"> <thead> <tr> <th colspan="2">Material</th> </tr> </thead> <tbody> <tr> <td>A</td> <td>Aluminum - 6061-T6 3000† psi • 20.7 MPa</td> </tr> <tr> <td>D</td> <td>Ductile Iron - D4512 5000† psi • 34.5 MPa</td> </tr> <tr> <td colspan="2">† Working pressure should be considered in accordance with ISO 4413 to determine appropriate material type.</td> </tr> </tbody> </table>	Material		A	Aluminum - 6061-T6 3000† psi • 20.7 MPa	D	Ductile Iron - D4512 5000† psi • 34.5 MPa	† Working pressure should be considered in accordance with ISO 4413 to determine appropriate material type.		<table border="1"> <thead> <tr> <th colspan="2">Circuit</th> </tr> </thead> <tbody> <tr> <td>P</td> <td>Parallel Circuit Standard Flow</td> </tr> </tbody> </table>	Circuit		P	Parallel Circuit Standard Flow	<table border="1"> <thead> <tr> <th colspan="2">Valve Spacing</th> </tr> </thead> <tbody> <tr> <td>5</td> <td>5.25 inch 133.4 mm</td> </tr> <tr> <td>7</td> <td>7.00 inch 177.8 mm</td> </tr> </tbody> </table>	Valve Spacing		5	5.25 inch 133.4 mm	7	7.00 inch 177.8 mm	<table border="1"> <thead> <tr> <th colspan="2">Options</th> </tr> </thead> <tbody> <tr> <td colspan="2">See next page for available options and ordering codes.</td> </tr> </tbody> </table>	Options		See next page for available options and ordering codes.		<table border="1"> <thead> <tr> <th colspan="2">Valve Pattern</th> </tr> </thead> <tbody> <tr> <td>D08</td> <td>ISO 4401-08-07 NFFPA T3.5.1-D08 See Tech Information</td> </tr> </tbody> </table>	Valve Pattern		D08	ISO 4401-08-07 NFFPA T3.5.1-D08 See Tech Information	<table border="1"> <thead> <tr> <th colspan="2">No. of Stations</th> </tr> </thead> <tbody> <tr> <td colspan="2">Aluminum</td> </tr> <tr> <td>01...08</td> <td>Available with spacing code 5</td> </tr> <tr> <td>02...05</td> <td>Available with spacing code 7</td> </tr> <tr> <td colspan="2">Ductile Iron</td> </tr> <tr> <td>01...08</td> <td>Available with spacing code 5</td> </tr> <tr> <td>02...05</td> <td>Available with spacing code 7</td> </tr> </tbody> </table>	No. of Stations		Aluminum		01...08	Available with spacing code 5	02...05	Available with spacing code 7	Ductile Iron		01...08	Available with spacing code 5	02...05	Available with spacing code 7	<table border="1"> <thead> <tr> <th colspan="2">Port Threads</th> <th>P,A,B</th> <th>T</th> <th>Y</th> <th>X optional</th> <th>GA</th> </tr> </thead> <tbody> <tr> <td>P</td> <td>NPTF • ANSI B1.20.3</td> <td>1.00</td> <td>1.25</td> <td>0.38</td> <td>0.25</td> <td>0.25</td> </tr> <tr> <td>S</td> <td>SAE • ISO 11926</td> <td>-16</td> <td>-20</td> <td>-8</td> <td>-4</td> <td>-6</td> </tr> <tr> <td>B</td> <td>BSPP • ISO 1179</td> <td>1.00</td> <td>1.25</td> <td>0.38</td> <td>0.25</td> <td>none</td> </tr> <tr> <td>M</td> <td>ISO • ISO 6149</td> <td>M33</td> <td>M42</td> <td>M14</td> <td>M10</td> <td>none</td> </tr> <tr> <td>T</td> <td>BSPT • ISO 7</td> <td>1.00</td> <td>1.25</td> <td>0.38</td> <td>0.25</td> <td>none</td> </tr> </tbody> </table>	Port Threads		P,A,B	T	Y	X optional	GA	P	NPTF • ANSI B1.20.3	1.00	1.25	0.38	0.25	0.25	S	SAE • ISO 11926	-16	-20	-8	-4	-6	B	BSPP • ISO 1179	1.00	1.25	0.38	0.25	none	M	ISO • ISO 6149	M33	M42	M14	M10	none	T	BSPT • ISO 7	1.00	1.25	0.38	0.25	none
Material																																																																																								
A	Aluminum - 6061-T6 3000† psi • 20.7 MPa																																																																																							
D	Ductile Iron - D4512 5000† psi • 34.5 MPa																																																																																							
† Working pressure should be considered in accordance with ISO 4413 to determine appropriate material type.																																																																																								
Circuit																																																																																								
P	Parallel Circuit Standard Flow																																																																																							
Valve Spacing																																																																																								
5	5.25 inch 133.4 mm																																																																																							
7	7.00 inch 177.8 mm																																																																																							
Options																																																																																								
See next page for available options and ordering codes.																																																																																								
Valve Pattern																																																																																								
D08	ISO 4401-08-07 NFFPA T3.5.1-D08 See Tech Information																																																																																							
No. of Stations																																																																																								
Aluminum																																																																																								
01...08	Available with spacing code 5																																																																																							
02...05	Available with spacing code 7																																																																																							
Ductile Iron																																																																																								
01...08	Available with spacing code 5																																																																																							
02...05	Available with spacing code 7																																																																																							
Port Threads		P,A,B	T	Y	X optional	GA																																																																																		
P	NPTF • ANSI B1.20.3	1.00	1.25	0.38	0.25	0.25																																																																																		
S	SAE • ISO 11926	-16	-20	-8	-4	-6																																																																																		
B	BSPP • ISO 1179	1.00	1.25	0.38	0.25	none																																																																																		
M	ISO • ISO 6149	M33	M42	M14	M10	none																																																																																		
T	BSPT • ISO 7	1.00	1.25	0.38	0.25	none																																																																																		

Options - D08 Standard Flow Parallel Manifold

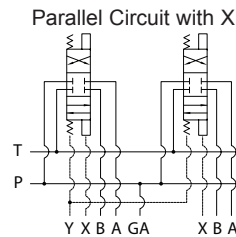
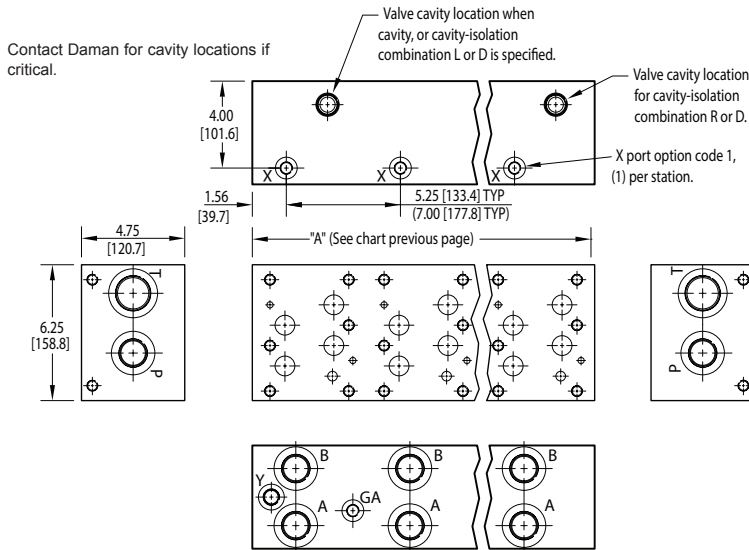

ISOLATIONS		
Daman isolation options allow a manifold to have two independent pressure and/or tank ports. Isolations are drilled rather than plugged to ensure a leakproof and failproof isolation.		
Ordering code letter:	* Isolation is between stations:	Available # of stations:
5.25 [133.4] spacing		
A	01 & 02	02-08
B	02 & 03	03-08
C	03 & 04	04-08
D	04 & 05	05-08
E	05 & 06	06-08
F	06 & 07	07-08
G	07 & 08	08
7.00 [177.8] spacing		
A	01 & 02	02-05
B	02 & 03	03-05
C	03 & 04	04-05
D	04 & 05	05

* Stations are numbered left to right.

Parallel Circuit with Cavity

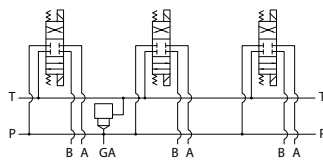

Valves with P in the nose and T out the side must be used.

Parallel Circuit with Isolations

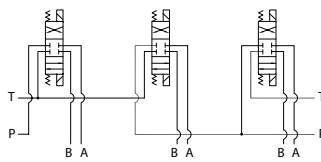

Manifold shown with P isolation between 1 & 2 (PA), and T isolation between 2 & 3 (TB).

Cavity & Isolation Combinations

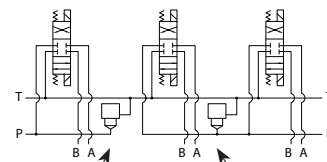

NOTES:

- 1) The GA port is not available on a (1) station manifold.
- 2) The GA port is not available when a pressure isolation is located between stations 1 & 2.

Ordering Information

